

Washington County School Nutrition Program

INVITATION FOR BID (IFB)

IFB #: _____

Invitation For Bid Timeline	
Bid Issue/Posting Date	Monday, March 3, 2025
Pre-Bid Meeting Date, Time and Location (if applicable)	N/A
Final Date for Written Questions	Friday, March 21, 2025
Bid Due Date and Time	April 2, 2025, 2:00 pm
Bid Due Location (deliver or mail to address)	Washington County Board of Education 501 Industrial Drive, PO Box 716, Sandersville, GA 31082 Attention: Karen Yonchak
Bid Opening Date and Time	April 2, 2025, 2:00 pm
Bid Opening Location	Washington County Board of Education 501 Industrial Drive, Sandersville, GA 31082
Recommendation to Washington County BOE	Thursday, April 3, 2025
Award of Contract	Friday, April 4, 2025
Contract Start Date and End Date (MM/DD/YYYY)	Any time after June 2, 2025 depending on completion of construction in the area
Awarded to (completed after awarded contract)	Vendor Name:

NOTE:

BID FOR	BID TYPE	LABEL SEALED ENVELOPE AS FOLLOWS:
<input type="checkbox"/>	Food	"IFB FOOD"
<input checked="" type="checkbox"/>	Equipment	"IFB EQUIPMENT- SCHOOL NUTRITION"
<input type="checkbox"/>	Paper, Chemical	"IFB PAPER AND CHEMICAL PRODUCTS"
<input type="checkbox"/>	Bread	"IFB BREAD"
<input type="checkbox"/>	Milk	"IFB MILK AND DAIRY PRODUCTS"
<input type="checkbox"/>	Kitchen Supplies	"IFB KITCHEN SUPPLIES"
<input type="checkbox"/>	Cafeteria Furnishings	"IFB CAFETERIA FURNISHINGS"
<input type="checkbox"/>	Ice Cream	"IFB ICE CREAM"
<input type="checkbox"/>	Other (identify)	"IFB (name other bid type identified here)"

DEFINITIONS

Addendum: A change, addition, alteration, correction or revision to a bid or contract document.

Bidder: A firm, individual, or corporation submitting a bid in response to this IFB.

CFR: Code of Federal Regulations

CN: Child Nutrition

Contract Documents: Consist of the Agreement between the School Nutrition Program and the Vendor, terms and conditions, schedule, specifications, drawings, any and all addenda, errata, and bulletins issued prior to execution of the contract, other documents listed in the Agreement, and modifications issued after execution of the contract.

EPA: Environmental Protection Agency

FNS: Food and Nutrition Services

F.O.B.: Freight on Board

HACCP: Hazard Analysis Critical Control Point

Invitation for Bid (IFB): A type of solicitation document used in competitive sealed bidding, where the primary consideration is cost, and the expectation is that competitive bids will be received, and an acceptance (award) will be made to the responsive and responsible Bidder whose bid is lowest in price and meets the specifications of the bid. An IFB is a formal method of procurement that uses sealed bidding and results in a fixed price contract with or without adjustment factors. The IFB must be publicly advertised, and bids shall be solicited from an adequate number of known suppliers, providing them with sufficient time to respond prior to the date set for opening the bids.

NSLP: National School Lunch Program

O.C.G.A.: Official Code of Georgia Annotated

OMB: Office of Management and Budget

SBP: School Breakfast Program

SFA: School Food Authority

SNP: School Nutrition Program

Solicitation: A document used by the School Nutrition Program to acquire goods and /or services. Solicitations must incorporate a clear and accurate description of the technical requirements for the material, product, or service to be procured. Solicitations must also identify all the requirements which the Offerors or Bidders must fulfill and all other factors to be used in evaluating the bids or proposals.

USDA: United States Department of Agriculture

U.S.C.: United States Code

Vendor: The provider of the goods and/or services under the Awarded Contract.
Document provided by the Georgia Department of Education School Nutrition Division

SECTION 1 PURPOSE AND PROCEDURES

The Washington County SFA, hereafter referred to as SFA, is issuing this Invitation for Bid (IFB) for the School Nutrition Program (SNP) and is requesting sealed bids for equipment.

INTENT

- a) It shall be the intent and purpose of this Invitation for Bid (IFB) to cover the terms and conditions under which a successful Bidder shall be responsible to supply and deliver products to the SFA, through sealed bids.
- b) School food authorities shall comply with the requirements of 7CFR 210.21 and 2 CFR part 200, subpart D and USDA implementing regulations 2 CFR part 400 and part 415, as applicable, which implement the applicable requirements, concerning the procurement of all goods and services with nonprofit school food service account funds. All procurement transactions must be conducted in a manner providing full and open competition consistent with the standards of this section. In order to ensure objective vendor performance and eliminate unfair competitive advantage, suppliers that develop or draft specifications, requirements, statement of work, or Invitation for Bids, must be excluded from competing for such procurements. (2 CFR 200.319)
- c) Any changes to the terms or conditions of this Contract, which are required by Federal or State law or rule, or changes to Federal or State laws, rules, or citations are automatically incorporated herein, effective as of the date specified in such law, rule and/or USDA Memo.
- d) The SFA is seeking to identify and select one (1) or more vendors to provide the items as listed in the attached list in *Attachment B*. The selected vendor(s) shall provide products in accordance with the Standard Terms and Conditions, Special Terms and Conditions, the IFB and any applicable Addenda.
- e) The SFA reserves the right to accept or reject any or all bids, or to accept any part of a bid without accepting the whole thereof, or to accept such bid as they deem to be in the best interest of the SFA without restricting competition

I. CONTRACT TIME PERIOD

- a) **Initial Term:** The initial term of this contract, which results from the award of this IFB, shall commence and terminate on the dates shown on the Invitation for Bid Timeline for School Year (SY)2025. The start date may not occur prior to the date on which the contract is signed, dated and awarded.
- b) **Extension Option:** The contract may be extended up to three (3) months at the same bid pricing, provided mutual agreement by both parties in written form.
- c) **Renewal Option:** This contract may be renewed by mutual agreement of both parties in written form. (Usually 1-year term with the option to renew 4 additional 1-year terms based on vendor performance.)

PRE-BID MEETING (If applicable)

If a pre-bid meeting will be scheduled under this solicitation, the date, time, and location is outlined in IFB Timeline. The Bidder should raise any questions it may have about the solicitation or the procurement at that time. A Bidder may not rely on any verbal responses to questions at the meeting. Material issues raised at the meeting that result in changes to the solicitation shall be answered solely through a solicitation addendum.

II. BID SUBMISSION PROCEDURES

The SFA is not liable for any costs incurred by Bidders prior to the issuance of or entering into a contract. Costs associated with developing the bid, preparing for oral presentations (if applicable), and any other expenses incurred by the Bidder in responding to this IFB are entirely the responsibility of the Bidder and shall not be reimbursed in any manner by the School Nutrition Program. If the Bidder is in doubt or has questions regarding the language, its meaning, or intent, it is the responsibility of the Bidder to seek clarification prior to submission of the bid.

BIDDER CONTACT INFORMATION

Bidder Company Name	
Street Address	
City, State, Zip	
Contact Person Name & Email address	
Telephone Number	

QUESTIONS CONCERNING BID:

Questions regarding this Invitation for Bid shall be directed to:

SFA Director Name or designee: Karen Yonchak

E-mail address kyonchak@washington.k12.ga.us

Responses to inquiries that affect the content of this IFB will be provided in writing to all recipients of the IFB. It is the responsibility of each Bidder to inquire about any aspect of the IFB that is not fully understood or is believed to be susceptible to more than one interpretation. The SFA will accept only written inquiries regarding this IFB until the date shown on the Invitation for Bid Timeline, in order for a reply to reach all Bidders before the bid closes and to give Bidders ample time to respond to any Addenda. Any information given to a prospective Bidder concerning an IFB, either during the pre-bid meeting or through written inquiries, will be furnished to all prospective Bidders as an Addendum to the IFB if such information is necessary or if the lack of such information would be prejudicial to uninformed Bidders.

BID PROCESS:

Bids must be enclosed in a sealed envelope. Emailed bids are not acceptable and will not be considered. Sealed bids must be received by the SFA no later than the date and time shown on the Invitation for Bid Timeline. Each bid will be time and date stamped to confirm receipt of the bid and documented.

- The outside of the envelope shall be clearly marked as shown on the timeline of this document and titled "IFB # for School Nutrition Equipment for Washington County". The return address on the envelope should include the vendor's complete mailing address.

- Sealed Bids shall be mailed or delivered to:

SFA Name: Washington County School Nutrition Program

Address: 501 Industrial Drive, PO Box 716

City, State, Zip Code: Sandersville, GA 31082

- An Excel electronic copy or paper copy of the bid Quote Sheet, along with any alternate or required information must be included inside the sealed bid package.
- Late bids shall not be accepted. The SFA shall not be responsible for late receipt of bids. Late bids will be returned unopened to the address provided.
- If the Bidder submits bid documents with informalities, errors, or omissions such as, but not limited to, non-conforming bid security, non-conforming non-collusion affidavit or fails to properly execute and seal the said documents the Bidder, in the SFA's sole discretion, may be given 72 hours from the time of the bid opening in which to provide such information to the SFA. The SFA has the right to waive any and all informalities.

III. BID OPENING DATE/TIME/PLACE

Bids will be opened at the date, time and location shown on the Invitation for Bid Timeline.

IV. AWARD DETERMINATION STATEMENT

- This IFB is intended to be awarded to a single or to multiple vendors and result in a firm fixed price contract. All bid prices shall remain firm for the contract period and in accordance with terms listed within the Escalation/De-escalation Clause, if applicable, located under Section 3: Method of Payment and Pricing Information.
- The award of this IFB is contingent upon available budget funds and approval of the SFA Board of Education.
- The SFA will award the contract to the lowest responsive and responsible Bidder(s) meeting all terms, conditions, and specifications of the IFB, within approximately sixty (60) days of the opening of the bids. Submitted bid pricing shall remain valid during this sixty-day period. The SFA reserves the right, in its sole discretion, to accept or reject any and all bids or parts thereof.
- An official letter/email of acceptance will be forwarded by the SFA to the successful Bidder after bid selection and prior to contract award.
- Upon acceptance and award of a vendor's bid, the contract between the Bidder and the SFA shall be drafted from (a) the IFB and addenda, (b) the selected bid response to the IFB by the Bidder and any attachments thereto, and (c) all written communications between the SFA and the Bidder.
- The contract shall constitute the entire and only agreement and shall supersede all prior negotiations, commitments, understandings, or agreements, whether oral or written

V. ADDITIONAL BID INSTRUCTIONS

- Bid modifications:** Bids cannot be modified after receipt of bids. Care should be taken to ensure that the information provided is accurate, complete, and consistent. Omission of any of the required information may subject the Bidder to disqualification. The SFA reserves the right to request information or respond to inquiries for clarification purposes only.
- Bid withdrawal:** Bidders may withdraw bids at any time up to the scheduled time for receipt of bids. Bidders desiring to withdraw their bid must submit the purpose for withdrawal in writing to the School Nutrition SFA before the bid opening deadline (bid close date). Bidders may resubmit bids provided it is prior to the scheduled time for receipt of bids.

c) Bid examination:

- i) Bidders shall carefully examine all documents in the solicitation to obtain knowledge of existing conditions, limitations, and requirements. Failure to examine the documents will not relieve the Bidder of responsibility for same nor will extra payment or change order requests be considered for conditions which could have been determined by examining the solicitation.
- ii) Bids will be considered as conclusive evidence of complete examination and understanding of the terms and conditions of the bid documents including the specifications and all requirements thereof of the IFB.

It is understood that submission of a bid indicates full acceptance of the same by the parties submitting the bid. Furthermore, by submitting a bid the Bidder waives the right to claims for additional time or monetary compensation for all work without limit required to complete the contract which could have been obtained by the Bidder through examination of all documents or raising a question regarding requirements prior to submitting a bid.

d) Rejection or Disqualification of bids

- i) A bid that is incomplete, obscure, conditioned or contains additions not called for or irregularities of any kind, (including alterations or erasures), which are not initialed and dated, may be rejected as non-conforming.
- ii) The SFA reserves the right to waive a bid's minor irregularities if rectified by Bidder within three business days of the School Nutrition Program's issuance of a written notice of such irregularities.
- iii) The SFA reserves the right to disqualify bids upon evidence of collusion with intent to defraud or other illegal practices upon the part of the Bidder.
- iv) Issuance of this IFB in no way constitutes a commitment by the SFA to award a contract. The SFA reserves the right to accept or reject, in whole or part, all bids submitted and/or to cancel this solicitation if it is determined to be in the best interest of the SFA.
- v) Any Bidder who has demonstrated and documented poor performance during a current or previous agreement, within the last 3 years (SFA indicates # of years to be excluded.), with the School Nutrition Program may be considered a non-responsible Bidder and their bid may be rejected. The SFA reserves the right to exercise this option as is deemed proper and/or necessary. (May ask for references here-include Attachment J, if desired, but if not remove attachment before posting)

e) Evidence of Financial Capabilities (not required: best practice): After the bid opening, Bidders must be prepared to present suitable evidence of their financial standing within three (3) business days after written request by the SFA. This evidence would include an income statement, balance sheet and statement of cash flow accompanied by an auditor's report attesting to the accuracy of the financial statements.

SECTION 2
STANDARD TERMS AND CONDITIONS

The signed and dated contract between the SFA and the Vendor shall be governed in accordance with the laws of the State of Georgia and all applicable Federal regulations.

I. LOBBYING CERTIFICATE (for bids over \$100k)

A Lobbying Certification and Disclosure must be completed for all bids \$100,000 and over. Byrd Anti-Lobbying Amendment (31 U.S.C. 1352): Vendors that apply or bid for an award exceeding \$100,000 must file the required certification. Each tier certifies to the tier above that it will not and has not used Federal appropriated funds to pay any person or organization for influencing or attempting to influence an officer or employee of any agency, a member of Congress, officer or employee of Congress, or an employee of a member of Congress in connection with obtaining any Federal contract, grant or any other award covered by 31 U.S.C. 1352. Each tier must also disclose any lobbying with non-Federal funds that takes place in connection with obtaining any Federal award. Such disclosures are forwarded from tier to tier up to the non-Federal award. See and complete *Attachment D*.

II. DEBARMENT AND SUSPENSION VERIFICATION (for bids over \$25k)

Institutions shall solicit offers from, award contracts to, and consent to subcontracts with responsible vendors and/or principals only. The serious nature of debarment and suspension requires that sanctions be imposed only in the public interest for the Government's protection and not for purposes of punishment. Institutions shall impose debarment or suspension to protect the Government's interest and only for the causes and in accordance with the procedures set forth in 2 CFR 200.213.

The Vendor certifies that the Vendor and/or any of its sub vendors or principals have not been debarred, suspended, or declared ineligible by any agency of the State of Georgia or any agency of the Federal government or as defined in the 2 CFR 200.213 which states "Non-federal entities are subject to the non-procurement debarment and suspension regulations implementing Executive Orders 12549 and 12689, 2 CFR part 180.

These regulations restrict awards, subawards, and contracts with certain parties that are debarred, suspended, or otherwise excluded from or ineligible for participation in Federal assistance programs or activities." The Vendor will immediately notify the School Food Authority if Vendor is debarred or placed on the Consolidated List of Debarred, Suspended, and Ineligible Vendors by a federal entity.

By signing this agreement, the Vendor is testifying that they are not debarred, suspended, or has any ineligible or voluntary exclusions with the U.S. Department of Agriculture or any other Federal or State Agency.

All responses will be verified. Debarment and Suspension (Executive Orders 12549 and 12689): A contract award (see 2 CFR 180.220) must not be made to parties listed on the governmentwide exclusions in the System for Award Management (SAM), in accordance with the OMB guidelines at 2 CFR 180 that implement Executive Orders 12549 (3 CFR part 1986 Comp., p. 189) and 12689 (3 CFR part 1989 Comp., p. 235), "Debarment and Suspension." SAM Exclusions contains the names of parties debarred, suspended, or otherwise excluded by agencies, as well as parties declared ineligible under statutory or regulatory authority other than Executive Order 12549. See *Attachment E*

III. BUY AMERICAN STATEMENT (Food only) (7 CFR Part 210.21(d))

Vendor must comply with the William F. Goodling Child Nutrition Reauthorization Act of 1998 (Buy American Act: 7 CFR 210.21(d)) which requires schools and institutions participating in the National School Lunch Program (NSLP) and School Breakfast Program (SBP) in the contiguous United States to purchase, to the maximum extent practicable, domestic commodities or products for use in meals served under the NSLP and SBP.

Buy American:

Definition of domestic commodity or product. The term 'domestic commodity or product' means:

- (i) An agricultural commodity that is produced in the United States; and

- (ii) A food product that is processed in the United States substantially using agricultural commodities that are produced in the United States. Substantial means over 51% of the final processed product consists of agricultural commodities that were grown domestically. Products from Guam, American Samoa, Virgin Islands, Puerto Rico, and the Northern Mariana Islands are allowed under this provision as territories of the United States.

The Buy American provision (7 CFR Part 210.21(d)) is one of the procurement standards SFAs must comply with when purchasing commercial food products served in the school meals programs. Exceptions to the Buy American provision are very limited; however, an alternative or exception may be approved by the SFA upon request. To be considered for an alternative or exception, the request must be submitted in writing to the SFA, a minimum of ___day (s) in advance of delivery. The request must include:

- (1) Alternative substitute(s) that are domestic and meet the required specifications:
 - (a) Price of the domestic food alternative substitute(s); and
 - (b) Availability of the domestic alternative substitute(s) in relation to the quantity ordered.
- (2) Reason for exception: limited/lack of availability or price (include price):
 - (a) Price of the domestic food product; and
 - (b) Price of the non-domestic product that meets the required specification of the domestic product.

By signing this document, the vendor certifies that all domestically identified products listed within the response to the attached specifications were processed in the U.S. and contain over 51% of their agricultural food components, by weight or volume, from the U.S. Any response listing a non-domestic product will include a valid resource to verify that the non-domestic good is not produced or manufactured in sufficient and reasonable available quantities of a satisfactory quality within the U.S.

DOMESTIC PREFERENCE FOR GOODS AND MATERIALS (Applicable to non-food only)

As appropriate and to the extent consistent with law, the non-Federal entity should, to the greatest extent practicable under a Federal award, provide a preference for the purchase, acquisition, or use of goods, products, or materials produced in the United States (including but not limited to iron, aluminum, steel, cement, and other manufactured products). The requirements of this section must be included in all subawards including all contracts and purchase orders for work or products under this award.

For purposes of this section:

- (1) "Produced in the United States" means, for iron and steel products, that all manufacturing processes, from the initial melting stage through the application of coatings, occurred in the United States.
- (2) "Manufactured products" means items and construction materials composed in whole or in part of non-ferrous metals such as aluminum; plastics and polymer-based products such as polyvinyl chloride pipe; aggregates such as concrete; glass, including optical fiber; and lumber.

IV. REMEDY FOR NON-PERFORMANCE/ TERMINATION OF CONTRACT

- (a) **Immediate Termination.** This contract will terminate immediately and absolutely if the SFA determines that adequate funds are not appropriated or granted or funds are de-appropriated such that the SFA cannot fulfill its obligations under the Contract, which determination is at the SFA's sole discretion and shall be conclusive. Further, the SFA may terminate the Contract for any one or more of the following reasons effective immediately without advance notice:

- (i) In the event the Vendor is required to be certified or licensed as a condition precedent to providing goods and services, the revocation or loss of such license or certification may result in immediate termination of the Contract effective as of the date on which the license or certification is no longer in effect;

- (ii) The SFA determines that the actions, or failure to act, of the Vendor, its agents, employees or sub vendors have caused, or reasonably could cause, life, health or safety to be jeopardized;
- (iii) The Vendor fails to comply with confidentiality laws or provisions; and/or
- (iv) The Vendor furnished any statement, representation, or certification in connection with the Contract or the bidding process, which is materially false, deceptive, incorrect, or incomplete.

(b) Termination for Cause. All contracts in excess of \$10,000 must address termination for cause and for convenience by the non-Federal entity including the manner by which it will be affected and the basis for settlement. The occurrence of any one or more of the following events shall constitute cause for the SFA to declare the Vendor in default of its obligation under the Contract:

- (i) The Vendor fails to deliver or has delivered nonconforming goods or services or fails to perform, to the SFA's satisfaction, any material requirement of the Contract or is in violation of a material provision of Contract, including, but without limitation, the express warranties made;
- (ii) The SFA determines that satisfactory performance of the Contract is substantially endangered or that a default is likely to occur;
- (iii) The Vendor fails to make substantial and timely progress toward performance of the Contract;
- (iv) The Vendor becomes subject to any bankruptcy or insolvency proceeding under federal or state law to the extent allowed by applicable federal or state law including bankruptcy laws; the Vendor terminates or suspends its business; or the SFA reasonably believes that the Vendor has become insolvent or unable to pay its obligations as they accrue consistent with applicable federal or state law;
- (v) The Vendor has failed to comply with applicable federal, state, and local laws, rules, ordinances, regulations and orders when performing within the scope of the Contract;
- (vi) The Vendor has engaged in conduct that has or may expose the SFA or the State to liability, as determined in the SFA's sole discretion; or
- (vii) The Vendor has infringed any patent, trademark, copyright, trade dress or any other intellectual property rights of the SFA, the state, or a third party.

(c) Notice of Default. If there is a default event caused by the Vendor, the SFA shall provide written notice to the Vendor requesting that the breach or noncompliance be remedied within the period of time specified in the SFA's written notice to the Vendor. If the breach or noncompliance is not remedied within the period of time specified in the written notice, the SFA may:

- (i) Immediately terminate the Contract without additional written notice; and/or
- (ii) Procure substitute goods or services from another source and charge the difference between the Contract and the substitute contract to the defaulting Vendor, and/or,
- (iii) Enforce the terms and conditions of the Contract and seek any legal or equitable remedies.

(d) Termination upon Notice. Following thirty (30) days' written notice, the SFA may terminate the Contract in whole or in part without the payment of any penalty or incurring any further obligation to the Vendor. Following termination upon notice, the Vendor shall be entitled to compensation, upon submission of invoices and proper proof of claim, for goods and services provided under the Contract to the SFA up to and including date of termination.

- (e) **Termination Due to Change in Law.** The SFA shall have the right to terminate this Contract without penalty by giving thirty (30) days' written notice to the Vendor as a result of the following:
- (i) The SFA's authorization to operate is withdrawn or there is a material alternation in the programs administered by the SFA; and/or
 - (ii) The SFA's duties are substantially modified.
- (f) **Payment Limitation in Event of Termination.** In the event of termination of the Contract for any reason by the SFA, the SFA shall pay only those amounts, if any, due and owing to the Vendor for goods and services actually rendered up to and including the date of termination of the Contract and for which the SFA is obligated to pay pursuant to the Contract or Purchase Instrument. Payment will be made only upon submission of invoices and proper proof of the Vendor's claim. This provision in no way limits the remedies available to the SFA under the Contract in the event of termination. The SFA shall not be liable for any costs incurred by the Vendor in its performance of the Contract, including, but not limited to, startup costs, overhead or other costs associated with the performance of the Contract.
- (g) **The Vendor's Termination Duties.** Upon receipt of notice of termination or upon request of the SFA, the Vendor shall:
- (i) Cease work under the Contract and take all necessary or appropriate steps to limit disbursements and minimize costs, and furnish a report within thirty (30) days of the date of notice of termination, describing the status of all work under the Contract, including, without limitation, results accomplished, conclusions resulting there from, and any other matters the SFA may require;
 - (ii) Immediately cease using and return to the SFA, any personal property or materials, whether tangible or intangible, provided by the SFA to the Vendor;
 - (iii) Comply with the SFA's instructions for the timely transfer of any active files and work product by the Vendor under the Contract;
 - (iv) Cooperate in good faith with the SFA, its employees, agents, and vendors during the transition period between the notification of termination and the substitution of any replacement vendor; and
 - (v) Immediately return to the SFA any payments made by the SFA for goods and services that were not delivered or rendered by the Vendor.

V. HUB (Historically Underutilized Business) STATEMENT

It is the intent of the SFA to provide maximum practicable opportunities in its solicitations to minority firms, women's business enterprises and labor surplus area firms.

Small businesses, women and minority-owned business sources and labor surplus area firms will not be given unfair advantage when evaluating competitive purchases i.e., small purchases, sealed bids, proposals, or noncompetitive procurement (2 CFR 200.321).

Positive efforts include:

- Placing qualified small and minority businesses, women's business enterprises and labor surplus area firms on solicitation lists;
- Assuring that small and minority businesses, women's business enterprises and labor surplus area firms are solicited whenever they are potential sources;
- Dividing total requirements, when economically feasible, into smaller tasks or quantities to permit maximum participation by small and minority businesses, women's business enterprises and labor surplus area firms;

- Establishing delivery schedules, where the requirement permits, which encourage participation by small and minority businesses, women's business enterprises and labor surplus area firms;
- Using the services and assistance, as appropriate, of such organizations as the Small Business Administration and the Minority Business Development Agency of the Department of Commerce; and
- Requiring the prime vendor, if subcontracts are to be let, to take the affirmative steps listed in paragraphs (1) through (5) of this section.

VI. EQUAL EMPLOYMENT OPPORTUNITY COMPLIANCE STATEMENT (for bids over \$10k)

In accordance with Federal Law and U.S. Department of Agriculture policy, this institution is prohibited from discriminating on the basis of race, color, national origin, sex, age, or disability. To file a complaint of discrimination, write USDA, Director, Office of Adjudication, 1400 Independence Avenue, SW, Washington, D.C. 20250-9410 or call toll free (866) 632-9992. (Voice) Individuals who are hearing impaired or have speech disabilities may contact USDA through the Federal Relay Service at (800) 877-8339; or (800) 845-6136 (Spanish). USDA is an equal opportunity provider and employer.

(Equal Employment Opportunity. Except as otherwise provided under 41 CFR Part 60, all contracts that meet the definition of "federally assisted construction contract" in 41 CFR Part 60-1.3 must include the equal opportunity clause provided under 41 CFR 60-1.4(b), in accordance with Executive Order 11246, "Equal Employment Opportunity" (30 FR 12319, 12935, 3 CFR Part, 1964-1965 Comp., p. 339), as amended by Executive Order 11375, "Amending Executive Order 11246 Relating to Equal Employment Opportunity," and implementing regulations at 41 CFR part 60, "Office of Federal Contract Compliance Programs, Equal Employment Opportunity, Department of Labor.")

VII. ENERGY POLICY AND CONSERVATION ACT STATEMENT

Compliance with mandatory standards and policies relating to energy efficiency which are contained in the state energy conservation plan issued in compliance with the Energy Policy and Conservation Act (Public Law 94-163, 89 Stat.871).

VIII. CLEAN AIR/ CLEAN WATER STATEMENT (for bids over \$150k)

Compliance with all applicable standards, orders, or requirements issued under section 306 of the Clean Air Act (42 U.S.C. 1857(h)) Clean Air and Water Certification. Vendor certifies that none of the facilities it uses to produce goods provided under the Contract are on the Environmental Protection Agency (EPA) List of Violating Facilities. Vendor will immediately notify the School Food Authority of the receipt of any communication indicating that any of Vendor's facilities are under consideration to be listed on the EPA List of Violating Facilities. Clean Air Act (42 U.S.C. 7401-7671q.) and the Federal Water Pollution Control Act (33 U.S.C. 1251-1387), as amended: Contracts and subgrants of amounts in excess of \$150,000 must contain a provision that requires the non-Federal award to agree to comply with all applicable standards, orders or regulations issued pursuant to the Clean Air Act (42 U.S.C. 7401-7671q) and the Federal Water Pollution Control Act as amended (33 U.S.C. 1251-1387). Violations must be reported to the Federal awarding agency and the Regional Office of the Environmental Protection Agency (EPA).

IX. RECORD RETENTION AND ACCESS CLAUSE

The Vendor shall maintain books, records and documents in accordance with generally accepted accounting principles and procedures and which sufficiently and properly document and calculate all charges billed to the SFA throughout the term of the Contract for a period of at least five (5) years following the date of final payment or completion of any required audit, whichever is later. Records to be maintained include both financial records and service records. The Vendor shall permit the Auditor of the State of Georgia or any authorized representative of the School Food Authority, and where federal funds are involved, the Comptroller General of the United States, or any other authorized representative of the United States government, to access and examine, audit, excerpt and transcribe any directly pertinent books, documents, papers,

electronic or optically stored and created records or other records of the Vendor relating to orders, invoices or payments or any other documentation or materials pertaining to the Contract, wherever such records may be located during normal business hours. The Vendor shall not impose a charge for audit or examination of the Vendor's books and records. If an audit discloses incorrect billings or improprieties, the State and/or the SFA's Board of Education reserves the right to charge the Vendor for the cost of the audit and appropriate reimbursement. Evidence of criminal conduct will be turned over to the proper authorities.

X. BID PROTEST PROCEDURES

a.) Any protest shall be in writing and shall be delivered to the SFA designated Protest official (list name of person here and contact information). A protest of a solicitation shall be received by the named individual before the offer due date. The protest shall be filed within ten (10) days from the award notice and shall include:

1. The name, address, and telephone number of the protestor;
2. The signature of the protestor or an authorized representative of the protestor;
3. Identification of the purchasing agency and the solicitation or contract number;
4. A detailed statement of the legal and factual grounds of the protest including copies of relevant documents;
5. The form of relief requested.

b) A written response to the protest will be made within 30 days from receipt of the protest and all items indicated above.

c) The SFA shall in all instances disclose information regarding protests to the State Agency.

XI. NON-COLLUSION STATEMENT

"I certify that this bid is made without prior understanding, agreement or connection with any corporation, firm or person submitting a bid for the same materials, supplies, or equipment, and is in all respect fair and without collusion or fraud. I understand that collusive bidding is a violation of State and Federal law and can result in fines, prison sentences, and civil damage awards. I agree to abide by all conditions of this bid and certify that I am authorized to sign this bid for the Bidder per O.C.G.A.50-5-67. I further certify that the provisions of the official code of Georgia annotated 45-10-20 et seq. have not and will not be violated in any respect." See *Attachment H*

XII. CODE OF CONDUCT

The following conduct will be expected from all persons who are engaged in the procurement process that uses School Nutrition Program funds including award, administration of contracts, and receipt of products. No employee, officer, or agent of the SFA shall participate in selection or in award or administration of a contract supported by the School Nutrition Program funds if conflict of interest, real or apparent, would be involved. Conflicts of interest arise when one of the following has a financial or other interest in the firm selected for the award:

- The employee, office, or agent;
- Any member of his/her immediate family;
- His or her partner;
- An organization which employs or is about to employ one of the above.

Further, the employees, officers, or agents shall neither solicit nor accept gratuities, favors, or anything of monetary value from vendors or parties to sub-agreements; and the purchase of any food or service from a vendor for individual use is prohibited; and the removal of any food, supplies, equipment, or school property, such as records, recipe books, supplies and the like is

prohibited; and outside sale of such items as used oil, empty cans, and the like will be sold by contract between the Board of Education and an outside agency. Individual sales by any school person to an outside agency or other school person is prohibited. Failure of any employee, officer, or agent to abide by the above states code could result in a fine, suspension, or both, and dismissal. Interpretation of the code will be given at any time by contacting the School Nutrition Department.

The SFA will not be responsible for any other explanation or interpretation which anyone presumes to make on behalf of the Board of Education.

XIII. DUTY TO EXAMINE

It is the responsibility of each Bidder to examine the entire solicitation, seek clarification in writing, and check for accuracy before submitting the offer. Lack of care in preparing shall not be grounds for withdrawing after the offer due date and time nor shall it give rise to any contract claim.

XIV. EXCEPTIONS TO TERMS AND CONDITIONS

A bid that takes exception to a material requirement of any part of this solicitation, including a material term and condition, shall be rejected.

XV. VELOCITY REPORT (where applicable)

Vendor shall supply a velocity report to the School Nutrition Director upon request. It must include Year to Date totals of individual items purchased.

XVI. VENDOR AFFIDAVIT (under O.C.G.A. § 13-10-91(b) (1))

Vendor verifies its compliance with O.C.G.A. § 13-10-91 and is authorized to use and uses the federal work authorization program commonly known as E-Verify, by completing *Attachment I*.

SECTION 3

SPECIAL TERMS AND CONDITIONS

I. HACCP (Hazard Analysis Critical Control Point) REQUIREMENTS (N/A to Equipment)

The SFA expects a Hazard Analysis Critical Control Point (HACCP) plan to be in place by potential vendors and their manufacturers. Prior to awarding the bid, the SFA may require documentation verifying that a written HACCP plan is followed.

The successful Bidder(s) must have Hazard Analysis Critical Control Point (HACCP) plan on file for recall/hold control procedures including but not limited to:

- traceability systems in place from receipt of commodity product(s) to delivery of processed items to designated delivery site(s).
- provision of 24/7 accessibility to successful Bidder(s) staff in the event of a food/USDA Hold/Recall.
- public notification capability on website to provide updates on food/USDA Hold and Recall data for customers.

Bidder(s) shall provide ability to SFA of conducting a mock recall for product once per year.

Bidder(s) will be responsible for all costs associated with replacement product(s), including but not limited to labor, shipping charges and product credit.

II. PROPRIETARY INFORMATION

If a Bidder submits any document with the bid that is considered to be proprietary in nature or is considered to be a trade secret, the Bidder shall notify the school district that the documents are included in the bid. The school district will honor the request unless or until a competing Bidder asks to have access to the information. In such case, the school district will notify the affected Bidder that a challenge has been made. If the affected Bidder can produce a court issued restraining order within ten calendar days subsequent to the notification, the information will remain confidential and shall not be released pending subsequent court action. If the restraining order is not received within the ten working day period, the information will be released, and the school district shall not be held liable.

III. TRADE NAME, LABELS AND OTHER REQUESTS (Where applicable)

- a) All items shall be properly labeled. No private labels will be accepted on commercial products.
- b) Nutrition data must be provided on all fresh, frozen, and canned meats, grains, combination foods, fruits, and vegetables. Provide information on a flash drive separate from the bid and marked "NUTRITIONAL INFORMATION." Or website access must be provided, complete with login information and web address for access with bid documents.
- c) In the event of loss of state or federal funds due to Bidder(s) failure to meet CN Label/Product Analysis requirements, the Bidder(s) shall reimburse losses to SFA.

IV. PRICING INFORMATION AND METHOD OF PAYMENT

- a) Prices: All prices offered shall be firm against any increase for ___ (insert #) days from the date of the contract award. Subsequently, the SFA may entertain a request for escalation/de-escalation on a (enter your preferred frequency, such as quarterly, 6 months, annual, etc.) basis. These price adjustments must be based on changes in market conditions and verified in accordance with the most recent publication from a valid third party.

(See examples below:

- [USDA Agricultural Marketing Service \(AMS\) Report](#),

- Yearly Percentage Change in the Consumer Price Index (CPI) for All Urban Consumers, as published by the U.S. Department of Labor, Bureau of Labor Statistics,
- Class I raw milk prices based on monthly USDA Federal Milk Order announcements for the applicable geographical zone (may wish to include additional stipulations for milk within this clause),
- And/or other valid third party.)

Request for price increases and/or decreases must be submitted to the SFA ___(insert #) days prior to taking effect. The aforementioned third-party publication/documentation must accompany requested price increases.

The SFA reserves the right to accept or reject the request for a price increase and will maintain documentation of approval or denial. If price increases escalate above ___(insert #) % per the awarded price of each product, the SFA reserves the right to provisionally purchase the product from another source if an equal and more reasonably priced option can be acquired, based on specifications. This clause also obligates vendor to provide price decreases from de-escalation on the same terms.

If administrative/operational fixed fees are also significantly affected by market conditions during periods of unprecedented economic instability, that are beyond the control of either the SFA or the vendor, a fixed fee price adjustment can also be increased up to ___(insert #) % on a (enter your preferred frequency, such as quarterly, 6 months, annual, etc.) basis. This fixed fee price increase must be verified by the current applicable CPI, such as the monthly CPI motor fuel index for times when fuel prices unexpectedly increase rapidly. The publication/documentation must accompany associated requested price increases.

- b) The successful Bidder warrants that the bid price(s), terms, and conditions stated in the bid shall be firm through the bid process and until the time the award is made at which time prices shall remain firm and fixed for the contract period and in accordance with terms listed within the Escalation/De-escalation Clause, if applicable.
- c) All bid prices must include all charges for packing and transporting to the individual schools listed at the addresses on the attached sheet. Separate fuel charges will not be added to invoices.
- d) Prices will not include Federal Excise Tax or State Sales Tax.
- e) The SFA will make payment within thirty (30) days of receipt of the invoice for properly received goods and services after inspection and acceptance of the product by the SFA. Advance billings are not allowed. When partial delivery is made, invoice for such part shall be made upon delivery, and payment made within thirty (30) days under the conditions as above.
- f) Invoicing
 - i) Invoices, at minimum, shall consist of the following information:
 1. Delivery location and date of delivery
 2. Item description and cost
 3. Extended cost for total quantity purchased
 4. Total cost of all products purchased
 5. Signature of acceptance
 - ii) Monthly statements will be broken down by school invoice and mailed or emailed to the:

SFA School Nutrition Director or designee

V. METHOD OF SHIPMENT/ORDERS & DELIVERY INFORMATION

- a) Orders and deliveries: Orders and deliveries shall be supplied by the vendor as requested and specified except during an emergency and on holidays. No partial deliveries will be accepted. Inspection: Upon delivery of product(s), the item(s) will be inspected by the facility, and if found to be defective or failing in any way to meet specifications as indicated, the item(s) may be rejected or returned. Problems found with products due to concealed damage will be addressed on a case-by-case basis. Rejected product(s) must be picked up immediately.

- b) Credit: Credit or replacement will be issued for damaged or unacceptable items. All such transactions are to be worked out with each designee. Replacement of damaged or unacceptable items will be made upon a mutually agreed time and date.
- c) All orders are to be delivered Freight on Board (F.O.B) to addresses as indicated on *Attachment C*.
- d) In an emergency situation in which the SFA requires delivery in less than 2 days and the vendor cannot provide the goods within the emergency delivery period, the SFA has the option to purchase those goods from another source with no penalty to either party.
- e) The SFA may have an occasional opportunity to purchase a limited amount of local fresh produce and reserves the right to do so for special occasions (such as Farm to School, Harvest of the Month, and other applicable School Nutrition educational opportunities).
- f) Delivery schedules that fall on a holiday will be made the following business day unless other arrangements have been made and agreed upon by both parties.
- g) Delivery of product(s) must be made in a well-maintained refrigerated truck, if applicable. All deliveries shall be placed in the area designated by the designee. Under no circumstances may a delivery be left outside the building. Deliveries must be received as specified.
- h) Two invoices are to be provided and must be reviewed and signed at the time of delivery and if any discrepancies are noted during delivery those will be initialed and dated by the driver and school nutrition employee receiving the order.

The Three Strikes Rule: (if applicable and warranted)

(1) After vendor's first offense of providing sub-par quality product, late delivery and/or poor customer service, the SFA will call vendor to report contract violation. The SFA will follow-up with a written letter to the vendor documenting occurrence and putting the vendor on notice that the documented occurrence is unacceptable.

(2) After vendor's second offense of providing sub-par product, late delivery and/or poor customer service, the SFA will send a certified notice to the vendor documenting that this is the second offense, and a third offense will result in termination of the contract for cause. If the offense is providing sub-par product, then the vendor agrees to pay the School Food Authority to purchase quality product at the vendor's expense.

(3) After the vendor's third and final offense of the aforementioned, the SFA will terminate the contract for cause in writing via email and regular mail, copying the District Purchasing Compliance Officer.

VI. EVALUATION FACTORS

- a) Bids will be evaluated in accordance with the required specifications as listed in this IFB. At the SFA's discretion, a bid may be eliminated from consideration for failure to comply with any required specifications, depending on the nature and extent of non-compliance. In addition to meeting mandated specifications, bids will be evaluated for the ability of the Bidder to provide, in the SFA's opinion, the best overall solution to meet the SFA's specifications.
- b) The SFA reserves the right to award a single contract for the total requirement of the IFB or award multiple contracts on a group or line-item basis in any combination that best serves the interest of the SFA.

VII. EQUIVALENT/ALTERNATE PRODUCTS

Equivalent/alternate products must be bid on items where a brand name or equal is specified, provided the quality, grade and/or performance of the proposed meets or exceeds the specifications as indicated within the bid specifications for each item. Samples of alternate/equivalent products shall be provided upon request as indicated below.

The following should be provided with the bid documents for all alternate/equivalent items bid:

1. Product identification, including manufacturer and/or distributor's name and number, brand name, product code, product label, quantity per case, case weight and item number.
2. Manufacturer's product literature/specifications, including but not limited to product description, ingredients, nutritional analysis, packaging wrap and/or product label.
3. Product has been personally investigated and determined that it is equal or superior in all respects to that specified.
4. Vendor will provide the same guarantee for the equivalent/alternate item as they would for specified product indicated in the bid documents.

VIII. SUBSTITUTION CLAUSE (where applicable)

Shipments of items with brand name or specifications other than those listed on the bid shall be rejected or returned to the vendor at the vendor's expense unless prior arrangements have been made with the Director of School Nutrition.

Substitutions may be made only with prior approval of the Director of School Nutrition.

All substitutions must be of equal or greater quality. In no case will an item be accepted if the quality is lower than stated in the bid. Substitutions are to be priced at the same cost as the original awarded item.

IX. AMENDMENTS AND MODIFICATIONS OF CONTRACT

The contract between the SFA and the Vendor shall not be amended or modified, nor shall any of its terms be waived, except in writing and executed and agreed upon by both parties.

X. ASSIGNMENT

The Vendor shall not assign, transfer, convey, delegate, sublet, or otherwise dispose of its agreements with the SFA, or its rights, title, or interest herein, or its power to execute such agreement, to any other person, company, or corporation without the previous consent and written approval by the SFA.

XI. INDEPENDENT VENDOR AND INDEMNITY

The Vendor shall act as an independent Vendor and not as an employee of the School Nutrition Program. Vendor agrees to indemnify and hold harmless the SFA, its elected officials, employees and agents from and against any and all liability, damages, claims, suits, liens, and judgments (including reasonable attorney's fees), of whatever nature, for injuries to or death of any person or persons, or loss of or damage to property, to the extent attributable to the negligent acts of vendor, its sub vendors or its respective agents, servants, or employees or such parties' failure to perform in accordance with the provisions of the contract resulting from this IFB.

XII. TIME OF PERFORMANCE

- a) Notwithstanding any delay in the preparation and execution of the formal contract agreement, the Vendor shall be prepared, upon written notice of bid award, to commence delivery of goods pursuant to the award on "Start Date" shown on the Invitation for Bid Timeline.
- b) The Vendor must comply with the time of performance.
- c) Vendor is responsible for notifying SFA that the order for items awarded has been submitted to manufacturer.

XIII. FORCE MAJEURE

If the SFA, in its reasonable discretion, determines that the Force Majeure Event is likely to delay Vendor's performance for more than thirty (30) days, the SFA reserves the right to cancel the agreement between the parties. In that event, neither party shall have any further liability to the other, subject only to the SFA's obligation to pay the Vendor for work already completed by the Vendor and the Vendor's warranty for work already completed.

XIV. EVIDENCE OF INSURANCE

- a) The successful Bidder, at its expense, shall always carry and maintain in full force during the term of the contract resulting from this IFB the following insurance: *(complete per your system's requirements)*

Coverage	Limits of Liability
Workmen's Compensation	Statutory
General Liability/Property Damage	\$500,000 each occurrence \$1,000,000 aggregate
Personal Injury	\$500,000 each occurrence \$1,000,000 aggregate
Automobile Liability/Property Damage	\$500,000 each occurrence
Bodily Injury	\$500,000 each occurrence \$1,000,000 aggregate

- b) Prior to commencement of performance of this Agreement, Vendor shall furnish to the SFA a certificate of liability insurance evidencing all required coverage in at least the limits required herein, naming the SFA, its elected officials, agents, and employees as additional insured under the Comprehensive General Liability coverage, and providing that no policies may be cancelled without ten (10) days advance written notice to the SFA. Such a certificate shall be issued to the SFA.
- c) Said policies shall remain in full force and effect until the expiration of the terms of the contract or until completion of all duties to be performed hereunder by the Vendor, whichever shall occur later.

XV. EXCEPTIONS

A Bid submitted in response to this IFB constitutes a binding offer to comply with all terms, conditions, special conditions, general specifications, and requirements stated in this IFB, except to the extent that a Bidder takes exception to such provisions. To take exception to a provision of this IFB, the Bidder must clearly identify in the BID EXCEPTION FORM:

- (a) the number and title of each section of this IFB that the Bidder takes exception to;
- (b) the specific sentence within such section that the Bidder takes exception to; and
- (c) any alternate provision proposed by the Bidder.

See *Attachment G*

XVI. WARRANTY

Successful Bidder shall fully warrant all products furnished under the terms of this contract, against poor and inferior quality. Time is of the essence of this contract. While under warranty, successful Bidder shall replace any damaged or inferior product in a timely manner to minimize the disruption of the SFA's operations.

XVII. GIFTS AND GRATUITIES

Acceptance of gifts from vendors and the offering of gifts by vendors are prohibited. No employee of the school district purchasing products under provisions of the contract issued as a result of this invitation shall accept, solicit, or receive, either directly or indirectly, from any person, firm, or corporation any gift or gratuity.

SAMPLES: The SFA reserves the right to request samples of any/all items indicated on the bid schedule. Samples shall be provided within five (5) business days upon request. It will be the responsibility of the supplier to incur all costs associated with the request for samples. Each sample is to be labeled with the Bidder's name, the item number as indicated on the Quote Sheets, and the bid number. Each sample must have a minimum of five (5) servings to be evaluated. Product labels on selected samples will be kept for verification when shipments are received. Products without such information may not be considered.

XVIII. SEVERABILITY

The provisions of this contract are severable. Any term or condition deemed illegal or invalid shall not affect any other term or condition of the contract.

XIX. WAIVER AND REJECTION RIGHTS

Notwithstanding any other provisions of the solicitation, the school district reserves the right to:

- Waive any immaterial defect or informality;
- Reject any and all offers or portions thereof; or
- Cancel a solicitation.

XX. RELEASE FROM CONTRACT

In the event the market for a product covered by this request escalates to a point that the vendor is delivering product at less than cost, the vendor may petition for release from the contract. The petition shall be supported by a third-party market bulletin. The decision to release the vendor from the contract will be based on the difference between the market at the time of the bid opening and the current market for this item.

XXI. PIGGYBACKING CLAUSE

The vendor agrees to allow the SFA and the following school districts (see *Attachment F* and each SFA piggybacking agreement form *Attachment F-1*) to have the same terms, cost, and conditions as this bid, during the time that this bid is in effect. SFAs may order items in quantities of one or more.

Any liability created by purchase orders issued against this agreement shall be the sole responsibility of the SFA placing the order. Prices and terms shall remain firm and in effect from the award of this bid, unless otherwise specified.

XXII. FOOD RECALLS AND BIOSECURITY (required only for processing bids at this time)

Vendor shall be expected to comply with all federal, state, and local mandates regarding the identification and recall of foods from the commercial and consumer marketplace. Vendor shall have a process in place to effectively respond to a food recall.

The process must include accurate and timely communications to the SFA and assurance that unsafe products are identified and removed from SFA sites in an expedient, effective, and efficient manner. Selected Vendor will be expected to maintain all paperwork required for immediate and proper notification of recalls for full and split cases. Vendor will define their policy and procedures for handling food recalls on a separate document to be submitted along with bid.

Vendor will provide the food recall contact person and the backup person's contact information to the school nutrition director or designee by completing the chart below. The SFA will provide the vendor with a contact person and a backup person's contact information by completing the chart below. Food recall procedures can be found in 7 CFR 250.

Food Recall Contact Information:

Company Name	
Contact Name	
Phone Number(s)	
E-mail address	
Back-Up Contact Name	
Phone Number(s)	
E-mail address	
School System Name	
School Nutrition Contact Name	
Phone Number(s)	
E-mail address	
Back-Up School Nutrition Contact Name	
Phone Number(s)	
E-mail address	

Biosecurity: Vendor must have a written policy regarding biosecurity and the food supply, in accordance with the Bioterrorism Act 2002 under the U.S. Department of Health and Human Services, FDA and under the USDA, Food Safety, and Inspection Service. Vendor will define their biosecurity policy and procedures on a separate document to be submitted along with bid.

XXIII. CONTRACT WORK HOURS/SAFETY STANDARDS ACT (40 U.S.C. 3701-3708) (where applicable)

All contracts awarded by the non-Federal entity in excess of \$100,000 that involve the employment of mechanics or laborers must include a provision for compliance with 40 U.S.C. 3702 and 3704, as supplemented by Department of Labor regulations (29 CFR Part 5). Under 40 U.S.C. 3702 of the Act, each vendor must be required to compute the wages of every mechanic and laborer on the basis of a standard work week of 40 hours.

Work in excess of the standard work week is permissible provided that the worker is compensated at a rate of not less than one and a half times the basic rate of pay for all hours worked in excess of 40 hours in the work week.

The requirements of 40 U.S.C. 3704 are applicable to construction work and provide that no laborer or mechanic must be required to work in surroundings or under working conditions that are unsanitary, hazardous, or dangerous. These requirements do not apply to the purchases of supplies, materials, or articles.

XXIV. DAVIS BACON ACT (for construction contracts in excess of \$2,000) [Appendix II to 2 CFR 200(d)] (if applicable)

Davis-Bacon Act, as amended (40 U.S.C. 3141-3148). When required by Federal program legislation, all prime construction contracts in excess of \$2,000 awarded by non-Federal entities must include a provision for compliance with the Davis-Bacon Act (40 U.S.C. 3141-3144, and 3146-3148) as supplemented by Department of Labor regulations (29 CFR Part 5, "Labor Standards Provisions Applicable to Contracts Covering Federally Financed and Assisted Construction"). In accordance with the statute, vendors must be required to pay wages to laborers and mechanics at a rate not less than the prevailing wages specified in a wage determination made by the Secretary of Labor. In addition, vendors must be required

to pay wages not less than once a week. The non-Federal entity must place a copy of the current prevailing wage determination issued by the Department of Labor in each solicitation. The decision to award a contract or subcontract must be conditioned upon the acceptance of the wage determination. The non-Federal entity must report all suspected or reported violations to the Federal awarding agency.

The contracts must also include a provision for compliance with the Copeland "Anti-Kickback" Act (40 U.S.C. 3145), as supplemented by Department of Labor regulations (29 CFR Part 3, "Vendors and Sub vendors on Public Building or Public Work Financed in Whole or in Part by Loans or Grants from the United States"). The Act provides that each vendor or subrecipient must be prohibited from inducing, by any means, any person employed in the construction, completion, or repair of public work, to give up any part of the compensation to which he or she is otherwise entitled. The non-Federal entity must report all suspected or reported violations to the Federal awarding agency.

XXV. RIGHTS TO INVENTIONS MADE UNDER A CONTRACT OR AGREEMENT (Appendix II to 2 CFR 200(f)) (if applicable)

If the Federal award meets the definition of "funding agreement" under 37 CFR § 401.2 (a) and the recipient or sub-recipient wishes to enter into a contract with a small business firm or nonprofit organization regarding the substitution of parties, assignment, or performance of experimental, developmental, or research work under that "funding agreement," the recipient or sub-recipient must comply with the requirements of 37 CFR Part 401, "Rights to Inventions Made by Nonprofit Organizations and Small Business Firms Under Government Grants, Contracts and Cooperative Agreements," and any implementing regulations issued by the awarding agency.

XXVI. PROCUREMENT OF RECOVERED MATERIALS (2 CFR 200.323) (if applicable)

An SFA and its vendors must comply with section 6002 of the Solid Waste Disposal Act, as amended by the Resource Conservation and Recovery Act. The requirements of Section 6002 include procuring only items designated in the guidelines of the Environmental Protection Agency (EPA) at 40 CFR part 247 that contain the highest percentage of recovered materials practicable, consistent with maintaining a satisfactory level of competition, where the purchase price of the item exceeds \$10,000 or the value of the quantity acquired during the preceding fiscal year exceeded \$10,000; procuring solid waste management services in a manner that maximizes energy and resource recovery; and establishing an affirmative procurement program for procurement of recovered materials identified in the EPA guidelines.

XXVII. PROHIBITION ON CERTAIN TELECOMMUNICATIONS AND VIDEO SURVEILLANCE SERVICES OR EQUIPMENT (2 CFR 200.2016) (if applicable)

Contractors and subcontractors are prohibited from using federal funds to enter into, extend or renew contracts for covered equipment, services, or systems that use covered telecommunications as a substantial or essential component of any system or critical technology as part of any system.

XXVIII. CIVIL RIGHTS STATEMENT AND ASSURANCE

The (INSERT SCHOOL FOOD AUTHORITY NAME) hereby agrees that it will comply with:

- i. Title VI of the Civil Rights Act of 1964 (42 U.S.C. 2000d et seq.);
- ii. Title IX of the Education Amendments of 1972 (20 U.S.C. 1681 et seq.);
- iii. Section 504 of the Rehabilitation Act of 1973 (29 U.S.C. 794);
- iv. Age Discrimination Act of 1975 (42 U.S.C. 6101 et seq.);
- v. Title II and Title III of the Americans with Disabilities Act (ADA) of 1990 as amended by the ADA Amendment Act of 2008 (42 U.S.C. 12131-12189);
- vi. Executive Order 13166, "Improving Access to Services for Persons with Limited English Proficiency." (August 11, 2000);
- vii. All provisions required by the implementing regulations of the Department of Agriculture (USDA) (7 CFR Part 15 et seq.); Department of Justice Enforcement Guidelines (28 CFR Parts 35, 42 and 50.3);
- viii. Food and Nutrition Service (FNS) directives and guidelines to the effect that, no person shall, on the

grounds of race, color, national origin, sex, age, or disability, be excluded from participation in, be denied the benefits of, or otherwise be subject to discrimination under any program or activity for which the Program applicant receives Federal financial assistance from USDA; and hereby gives assurance that it will immediately take measures necessary to effectuate this Agreement.

- ix. The USDA non-discrimination statement that in accordance with Federal civil rights law and U.S. Department of Agriculture (USDA) civil rights regulations and policies, the USDA, its Agencies, offices, and employees, and institutions participating in or administering USDA programs are prohibited from discriminating based on race, color, national origin, religion, sex, gender identity (including gender expression), sexual orientation, disability, age, marital status, family/parental status, income derived from a public assistance program, political beliefs, or reprisal or retaliation for prior civil rights activity, in any program or activity conducted or funded by USDA (not all bases apply to all programs).

This assurance is given in consideration of and for the purpose of obtaining any and all Federal financial assistance, grants, and loans of Federal funds, reimbursable expenditures, grant, or donation of Federal property and interest in property, the detail of Federal personnel, the sale and lease of, and the permission to use Federal property or interest in such property or the furnishing of services without consideration or at a nominal consideration, or at a consideration that is reduced for the purpose of assisting the recipient, or in recognition of the public interest to be served by such sale, lease, or furnishing of services to the recipient, or any improvements made with Federal financial assistance extended to the Program applicant by USDA. This includes any Federal agreement, arrangement, or other contract that has as one of its purposes the provision of cash assistance for the purchase of food, and cash assistance for purchase or rental of food service equipment or any other financial assistance extended in reliance on the representations and agreements made in this assurance.

By accepting this assurance, the (INSERT SCHOOL FOOD AUTHORITY NAME) agrees to compile data, maintain records, and submit records and reports as required, to permit effective enforcement of nondiscrimination laws and permit authorized USDA personnel during hours of program operation to review and copy such records, books, and accounts, access such facilities and interview such personnel as needed to ascertain compliance with the nondiscrimination laws. If there are any violations of this assurance, the Department of Agriculture, FNS, shall have the right to seek judicial enforcement of this assurance. This assurance is binding on the (INSERT SCHOOL FOOD AUTHORITY NAME), its successors, transferees, and assignees as long as it receives assistance or retains possession of any assistance from USDA. The person or persons whose signatures appear below are authorized to sign this assurance on behalf of the (INSERT SCHOOL FOOD AUTHORITY NAME).

Signature: _____ Title: _____

Printed Name: _____

ATTACHMENT A

BIDDER SUBMISSION FORM

Notice to Bidders:

It is essential that the submitted Bid complies with all the requirements contained in this IFB. The undersigned Bidder agrees, if this bid is accepted, to enter into an agreement with the SFA on the form included in the Contract Documents to perform and furnish all products as specified or indicated in the contract documents.

This Bid is submitted to: Washington County School Nutrition Program

This Bid is submitted on this date: _____

This Bid is valid for sixty (60) days from the date of the public opening of the bids.

Communications and questions regarding this bid are to be directed to:

School Nutrition Director : Karen Yonchak

Email address: kyonchak@washington.k12.ga.us

Receipt of Addenda:

In submitting this Bid, Bidder represents that they have received and examined the following Addenda (if applicable):

Addendum 1 _____ Date _____

Addendum 2 _____ Date _____

Checklist for Bidder:

The following documents are attached to and made part of the Bid (check all that applies):

- Specifications Lobbying Certificate Debarment Status Form Piggybacking Participation Form
- Bid Exception Form Anti-Collusion Vendor Affidavit Reference Form (if requested)
- Contract Signature Page (signed and dated after award)

Bid Pricing

Unless items are specifically excluded in the Bid, the SFA shall deem the Bid to be complete and shall not be charged any costs above and beyond the Bid amount as set forth by the Bidder herein.

Total Bid Price: \$ _____

Authorized Signature of Bidder: (This bid submission form must be signed by an individual with actual authority to bind the company.)

Company Type (check one):

Sole Proprietorship Partnership Corporation Joint Venture LLC

Bidder attests that:

They have thoroughly reviewed this IFB and that this Bid response is submitted in accordance with the IFB requirements.

Company Name: _____

Federal ID#1: _____

Street Address: _____

Signature**:

Signatory's Name: _____

Signatory's Title: _____

Witness's Signature**:

Witness's Name: _____

Witness's Title: _____

**For Corporations: The bid must be signed by the President or Vice President and the signature must be attested by the Corporate Secretary or Treasurer.

If any employee other than the President or Vice President signs on behalf of the corporation, or if the President's or Vice President's signature is not attested to by the Corporate Secretary or Treasurer, a copy of the corporate resolution authorizing said signature(s) must be attached to this bid. Failure to attach a copy of the appropriate authorization, if required, may result in rejection of the bid.

ATTACHMENT B
Specifications & Quote Sheet

(SEE ATTACHMENTS)

DEFINITIONS (if applicable) :

Bid Unit: The unit designation which shall be applicable to all pricing offered for bid evaluation purposes. Unit cost, freight, fixed fee, estimated usage, and the extended cost shall be stated in terms of the designated bid unit. In some instances, the bid unit and the package unit may be the same.

Pack size: With some items the bid unit does not represent a package configuration by which the item would normally be purchased. In such instances, the Bidder will be required to bid according to the designated bid unit and also state how the product will be packaged and to provide a cost for purchase unit.

Purchase Unit: The package configuration (case, carton, box, bag, etc.) by which the product would normally be sold. This shall also mean packaging being referred to when the term "case price" is applicable.

ATTACHMENT C

DELIVERY SITE(S)

Washington County School Nutrition Program

All items will be delivered to the following SCHOOL locations:

School/Location Name	School/Location Address	Cafeteria/Location Phone Number
<u>TJ Elder Middle School</u>	<u>902 Linton Road Sandersville, GA 31082</u>	<u>Same address 478-552- 3981, ext 1211</u>



ATTACHMENT D

LOBBYING CERTIFICATION DISCLOSURE

**CERTIFICATION REGARDING LOBBYING - CONTRACTS, GRANTS, LOANS
AND COOPERATIVE AGREEMENTS**

The undersigned certifies, to the best of his or her knowledge and belief, that:

(1) No Federal appropriated funds have been paid or will be paid, by or on behalf of the undersigned, to any person for influencing or attempting to influence an officer or employee of any agency, a Member of Congress, an officer or employee of Congress, or an employee of a Member of Congress in connection with the awarding of any Federal contract, the making of any Federal grant, the making of any Federal loan, the entering into of any cooperative agreement, and the extension, continuation, renewal, amendment, or modification of any Federal contract, grant, loan or cooperative agreement;

(2) If any funds other than Federal appropriated funds have been paid or will be paid to any person for influencing or attempting to influence an officer or employee of any agency, a Member of Congress, an officer or employee of Congress, or an employee of a Member of Congress in connection with this

Federal contract, grant, loan, or cooperative agreement, the undersigned shall complete and submit Standard Form-LLL, "Disclosure Form to Report Lobbying," in accordance with its instructions;

(3) The undersigned shall require that the language of this certification be included in the award documents for all subawards at all tiers (including subcontracts, subgrants, and contracts under grants, loans, and cooperative agreements) and that all subrecipients shall certify and disclose accordingly.

This certification is a material representation of fact upon which reliance was placed when this transaction was made or entered into. Submission of this certification is a prerequisite for making or entering into this transaction imposed by section 1352, title 31, U.S. Code. Any person who fails to file the required certification shall be subject to a civil penalty of not less than \$10,000 and not more than \$100,000 for each such failure.

Organization Name

Award Number or Project Name

Name and Title of Authorized Representative

Signature

Date

ATTACHMENT E

AD-1047

OMB No. 0505-0027
Expiration Date: 09/30/2025



**Certification Regarding Debarment, Suspension, and Other Responsibility Matters
Primary Covered Transactions**

The following statement is made in accordance with the Privacy Act of 1974 (5 U.S.C. § 552a, as amended). This certification is required by the regulations implementing Executive Order 12549, Debarment and Suspension, and 2 CFR § 180.335, Participants' responsibilities. The regulations were amended and published on August 31, 2005, in 70 Fed. Reg. 51865-51880. Copies of the regulations may be obtained by contacting the Department of Agriculture agency offering the proposed covered transaction.

According to the Paperwork Reduction Act of 1995, an agency may not conduct or sponsor, and a person is not required to respond to a collection of information unless it displays a valid OMB control number. The valid OMB control number for this information collection is 0505-0027. The time required to complete this information collection is estimated to average 15 minutes per response, including the time for reviewing instructions, searching existing data sources, gathering and maintaining the data needed, and completing and reviewing the collection of information. The provisions of appropriate criminal or civil fraud, privacy, and other statutes may be applicable to the information provided.

(Read instructions on page two before completing certification.)

A. The prospective primary participant certifies to the best of its knowledge and belief, that it and its principals:

1. Are not presently debarred, suspended, or proposed for debarment, declared ineligible, or voluntarily excluded from covered transactions by any Federal department or agency;
2. Have not within a 3-year period preceding this proposal been convicted of or had a civil judgment rendered against them for commission of fraud or a criminal offense in connection with obtaining, attempting to obtain, or performing a public (Federal, State or local) transaction or contract under a public transaction; violation of Federal or State antitrust statutes or commission of embezzlement, theft, forgery, bribery, falsification or destruction of records, making false statements, or receiving stolen property;
3. Are not presently indicted for or otherwise criminally or civilly charged by a governmental entity (Federal, State or local) with commission of any of the offenses enumerated in paragraph (A.2.) of this certification; and
4. Have not within a 3-year period preceding this application/proposal had one or more public transactions (Federal, State or local) terminated for cause or default.

B. Where the prospective primary participant is unable to certify to any of the statements in this certification, such prospective participant shall attach an explanation to this proposal.

ORGANIZATION NAME	PR/AWARD NUMBER OR PROJECT NAME
NAME(S) AND TITLE(S) OF AUTHORIZED REPRESENTATIVE(S)	
SIGNATURE	DATE

In accordance with Federal civil rights law and U.S. Department of Agriculture (USDA) civil rights regulations and policies, the USDA, its Agencies, offices, and employees, and institutions participating in or administering USDA programs are prohibited from discriminating based on race, color, national origin, religion, sex, gender identity (including gender expression), sexual orientation, disability, age, marital status, family/parental status, income derived from a public assistance program, political beliefs, or reprisal or retaliation for prior civil rights activity, in any program or activity conducted or funded by USDA (not all bases apply to all programs). Remedies and complaint filing deadlines vary by program or incident.

Persons with disabilities who require alternative means of communication for program information (e.g., Braille, large print, audiotope, American Sign Language, etc.) should contact the responsible Agency or USDA's TARGET Center at (202) 720-2600 (voice and TTY) or contact USDA through the Federal Relay Service at (800) 877-8339. Additionally, program information may be made available in languages other than English.

To file a program discrimination complaint, complete the USDA Program Discrimination Complaint Form, AD-3027, found online at [How to File a Program Discrimination Complaint](#) and at any USDA office or write a letter addressed to USDA and provide in the letter all of the information requested in the form. To request a copy of the complaint form, call (866) 632-9992. Submit your completed form or letter to USDA by: (1) mail: U.S. Department of Agriculture, Office of the Assistant Secretary for Civil Rights, 1400 Independence Avenue, SW, Washington, D.C. 20250-9410; (2) fax: (202) 690-7442; or (3) email: program_inlake@usda.gov.

USDA is an equal opportunity provider, employer, and lender.



Instructions for Certification

- 1) By signing and submitting this form, the prospective primary participant is providing the certification set out on page 1 in accordance with these instructions.
- 2) The inability of a person to provide the certification required below will not necessarily result in denial of participation in this covered transaction. The prospective participant must submit an explanation of why it cannot provide the certification set out on this form. The certification or explanation will be considered in connection with the Department or agency's determination whether to enter into this transaction. However, failure of the prospective primary participant to furnish a certification or an explanation will disqualify such person from participation in this transaction.
- 3) The certification in this clause is a material representation of fact upon which reliance was placed when the Department or agency determined to enter into this transaction. If it is later determined that the prospective primary participant knowingly rendered an erroneous certification, in addition to other remedies available to the Federal Government, the Department or agency may terminate this transaction for cause or default
- 4) The prospective primary participant must provide immediate written notice to the Department or agency to which this proposal is submitted if at any time the prospective primary participant learns that its certification was erroneous when submitted or has become erroneous by reason of changed circumstances.
- 5) The terms "covered transaction," "debarred," "suspended," "ineligible," "lower tier covered transaction," "participant," "person," "primary covered transaction," "principal," "proposal," and "voluntarily excluded," as used in this clause, have the meanings set out in the Definitions and Coverage sections of the rules implementing Executive Order 12549, at 2 CFR Parts 180 and 417. You may contact the Department or agency to which this proposal is being submitted for assistance in obtaining a copy of those regulations.
- 6) The prospective primary participant agrees by submitting this form that, should the proposed covered transaction be entered into, it may not knowingly enter into any lower tier covered transaction with a person who is debarred, suspended, declared ineligible, or voluntarily excluded from participation in this covered transaction, unless authorized by the Department or agency entering into this transaction.
- 7) The prospective primary participant further agrees by submitting this form that it will include the clause titled "Certification Regarding Debarment, Suspension, Ineligibility and Voluntary Exclusion - Lower Tier Covered Transactions," provided by the Department or agency entering into this covered transaction, without modification, in all lower tier covered transactions and in all solicitations for lower tier covered transactions.
- 8) A participant in a covered transaction may rely upon a certification of a prospective participant in a lower tier covered transaction that is not debarred, suspended, ineligible, or voluntarily excluded from the covered transaction, unless it knows that the certification is erroneous. A participant may decide the method and frequency by which it determines the eligibility of its principals. Each participant may, but is not required to, check the General Services Administration's System for Award Management Exclusions database.
- 9) Nothing contained in the foregoing shall be construed to require establishment of a system of records in order to render in good faith the certification required by this clause. The knowledge and information of a participant is not required to exceed that which is normally possessed by a prudent person in the ordinary course of business dealings.
- 10) Except for transactions authorized under paragraph (6) of these instructions, if a participant in a covered transaction knowingly enters into a lower tier covered transaction with a person who is suspended, debarred, ineligible, or voluntarily excluded from participation in this transaction, in addition to other remedies available to the Federal Government, the Department or agency may terminate this transaction for cause or default.

ATTACHMENT F
LIST OF SFAs DESIRING TO PIGGYBACK

IFB # (Enter #)

SFA Name	Director	Email	Telephone	Address

The SFA will provide this list of SFAs desiring to "Piggyback" on a contract with the awarded Vendor (as applicable). Any SFA wishing to piggyback must complete the following agreement (Attachment F-1) to be approved by the Contractor once awarded.



**ATTACHMENT F-1
LIST OF SCHOOL SYSTEMS THAT DESIRE TO PIGGYBACK**

SCHOOL DISTRICT PIGGYBACKING PARTICIPATION AGREEMENT

IFB FOR: _____ (INSERT BID TYPE)

IFB #: _____

SCHOOL YEAR: _____

The *(Insert)* School Food Authority agrees to this piggybacking provision to enter into a contract with *(Insert the awarded vendor)* for the purchase of the items described herein in this bid document based on the same terms, conditions, prices and products offered by the successful vendor to *(Insert Name of system that you are piggybacking off)* SFA School District.

Minor changes in delivery terms and conditions, number of schools and delivery frequencies may be discussed by participating SFA for up to 30 days following the award of this contract. The following SFA *may* participate in the final contract.

NAME OF SCHOOL DISTRICT: _____

ADDRESS: _____

SCHOOL NUTRITION DIRECTOR: _____

PHONE: _____ EMAIL: _____

NUMBER OF SCHOOLS: _____

DELIVERY FREQUENCY: _____

(Example: 1 x a week; 2 x a week; daily, etc.)

School District Authority Signature:

Awarded Vendor Signature:

Title: _____

Title: _____

Name: (printed)

Name of Company: (printed)

ATTACHMENT G
BID EXCEPTION FORM

Vendor Name:	Invitation for Bid (IFB) for: School System: Type:	Date of Submittal:
Number and Title of each section of IFB that Bidder takes exception	Number and Title : Section:	Number and Title : Section:
Specific Sentence within each section	Sentence:	Sentence:
Alternate Provisions proposed by Bidder	Alternate:	Alternate:
Vendor's Authorization Signature:		
Vendor's Authorization printed name:		
Vendor's Title:		

ATTACHMENT H
ANTI-COLLUSION AFFIDAVIT

STATE OF: _____

SFA OF: _____

_____, of lawful age, being first sworn on oath say, that they are the agent authorized by the Bidder to submit the attached bid. Affiant further states that the Bidder has not been a party to any collusion among Bidders in restraint of freedom of competition by agreement to bid at a fixed price or to refrain from bidding; or with any state official or employee to quantity, quality, or price in the prospective contract, or any other terms of said prospective official concerning exchange of money or other thing of value for special consideration in the letting of contract; that the Bidder/vendor had not paid, given or donated, or agreed to pay, give or donate to any officer or employee either directly or indirectly in the procuring of the award of a contract pursuant to this bid.

Signed

Subscribed and sworn before me this _____ day of _____, 20__.

Notary Public (or Clerk or Judge) __

My commission expires: _____

ATTACHMENT I
VENDOR AFFIDAVIT

By executing this affidavit, the undersigned vendor verifies its compliance with O.C.G.A. § 13-10-91(b)(1), stating affirmatively that the individual, firm or corporation which is engaged in the physical performance of services on behalf of SFA has registered with, is authorized to use and uses the federal work authorization program commonly known as E-Verify, or any subsequent replacement program, in accordance with the applicable provisions and deadlines established in O.C.G.A. § 13-10-91. Furthermore, the undersigned vendor will continue to use the federal work authorization program throughout the contract period and the undersigned vendor will contract for the physical performance of services in satisfaction of such contract only with sub vendors who present an affidavit to the vendor with the information required by O.C.G.A. § 13-10-91(b). Vendor hereby attests that its federal work authorization user identification number and date of authorization are as follows:

E-Verify Number (4 to 6 digit number) _____

Date of Authorization _____

Name of Vendor _____

_____(INSERT SCHOOL FOOD AUTHORITY NAME)

I hereby declare under penalty of perjury that the foregoing is true and correct.

Executed on _____, _____, 20____ in _____ (city), _____ (state).

Signature of Authorized Officer or Agent

Printed Name and Title of Authorized Officer or Agent

SUBSCRIBED AND SWORN BEFORE ME

ON THIS THE _____ DAY OF _____, 20____.

NOTARY PUBLIC

My Commission Expires: _____

ATTACHMENT J

Bidder Reference Form

As a part of the IFB process, the SFA requires Bidders to submit business references within this solicitation. The purpose of these references is to document the experience relevant to the scope of work and aid in the award process.

Company Name:		IFB Solicitation #:		
Business or School System Name	Address	Contact Name and Phone Number	Email address	Dates of Service To/From:

VENDOR CONTRACT SIGNATURE PAGE

(Signed and dated AFTER Contract Award)

This Contract is dated as of _____ by and between the _____

Washington County School Food Authority, hereinafter called SFA, and _____, hereinafter called
VENDOR.

The SFA and VENDOR, in consideration of the mutual covenants hereinafter set forth, agrees as follows:

ARTICLE 1. PRODUCTS

VENDOR shall provide and deliver all products as specified or indicated in the Contract Documents.

ARTICLE 2. CONTRACT TIME

The food, equipment, supplies or goods shall be in accordance with this Contract Agreement, and are to be completed as specified in IFB.

ARTICLE 3. CONTRACT PRICE

The SFA shall pay VENDOR for delivery of specified goods in accordance with VENDOR'S bid, which is attached hereto. The SFA shall pay VENDOR net 30 days from date of delivery unless other terms of payment are agreed upon in writing.

ARTICLE 4. INVOICE PROCEDURES

Invoices for payment with appropriate supporting documents shall be sent to the following address:

(INSERT SFA NAME)

School Nutrition Program

Address:

City, State, Zip Code:

ARTICLE 5. VENDOR'S REPRESENTATIONS

In order to prompt the School Nutrition Program to enter into this Agreement, VENDOR makes the following representations:

5.1 VENDOR has examined and carefully studied the Contract Documents and all other related data identified in the Bidding Documents.

5.2 VENDOR is familiar with and is satisfied with all federal, state and local laws and regulations that may affect the cost, progress, performance and furnishing of the products.

ARTICLE 6. CONTRACT DOCUMENTS

The Contract Documents, which comprise the entire Contract/agreement between the SFA and VENDOR concerning the work, consist of the following:

- Purpose and Procedures
- Standard Terms and Conditions
- Special Terms and Conditions
- Attachment A: Bidder Submission Form
- Attachment B: Specifications & Quote Sheet
- Attachment C: Delivery Site(s)
- Attachment D: Lobbying Certification Disclosure
- Attachment E: Debarment, Suspended and Ineligible Status
- Attachment F: Piggybacking Agreement Form
- Attachment G: Bid Exception Form
- Attachment H: Anti-Collusion Affidavit
- Attachment I: Vendor Affidavit (E-Verify)
- Attachment J: Bidder Reference Form
- Vendor Contract Signature Page

There are no Contract Documents other than those listed above in this Article 6. The Contract Documents may only be amended, modified, or supplemented by written agreement between both parties.

CONTRACT SIGNATURES

IN WITNESS WHEREOF, the SFA and VENDOR have signed this Contract Agreement **once awarded**. One counterpart each has been delivered to the SFA and VENDOR.

This Contract Agreement will be effective _____, 20____ for School Year (SY)' _____.

_____ SFA Board of Education

_____ Signature of Superintendent, Board member or designee

_____ Printed Name of Superintendent, Board member or designee

_____ Date Signed (MM/DD/YYYY)

_____ Vendor Company Name

_____ Signature of Company Representative

_____ Printed Name of Company Representative

_____ Date Signed (MM/DD/YYYY)



DUKE MANUFACTURING COMPANY
 2505 North Broadway
 Littleton, Colorado 80120
 Phone: (303) 733-1350
 Fax: (303) 733-1074

REVISIONS

NO.	DATE	BY	APP.	DESCRIPTION
1		J.P.		ISSUED FOR PERMITS
2		J.P.		ISSUED FOR PERMITS
3		J.P.		ISSUED FOR PERMITS
4		J.P.		ISSUED FOR PERMITS

REVISIONS

NO.	DATE	BY	APP.	DESCRIPTION
1		J.P.		ISSUED FOR PERMITS
2		J.P.		ISSUED FOR PERMITS
3		J.P.		ISSUED FOR PERMITS
4		J.P.		ISSUED FOR PERMITS

REVISIONS

NO.	DATE	BY	APP.	DESCRIPTION
1		J.P.		ISSUED FOR PERMITS
2		J.P.		ISSUED FOR PERMITS
3		J.P.		ISSUED FOR PERMITS
4		J.P.		ISSUED FOR PERMITS

DESIGNED BY: **PMR**
 DRAWN BY: **J.P.**
 ESTIMATOR: **CAM**
 ESTIMATOR: **J.A. STRITZEL**
 PROJECT NO.:
 ORDER NO.: **N/A**
 UNIT: **1000000000**
 QUANTITY: **1**
 DRAWING NO.: **SFO-0001273**
 SHEET: **5** OF **1**

THIS DRAWING AND THE INFORMATION AND DATE CONTAINED HEREIN ARE THE CONFIDENTIAL AND PROPRIETARY PROPERTY OF DUKE MANUFACTURING CO., AND MAY NOT BE REPRODUCED OR DISCLOSED FOR ANY PURPOSE, WITHOUT THE WRITTEN PERMISSION OF DUKE MANUFACTURING CO.

STANDARD SERVING SYSTEM PRACTICES

- SOLID SURFACE TOPS AND TRAY SLIDES**
- ALL SOLID SURFACE TOPS AND TRAY SLIDES, WITH FELD SEAMS, WILL SHIP LOOSE WHEN SPANNING MORE THAN ONE UNIT.
 - SOLID SURFACE TOPS AND TRAY SLIDES SPECIFIC TO SINGLE UNIT WILL SHIP ASSEMBLED.
 - SOLID SURFACE TOPS AND TRAY SLIDES REQUIRE A CERTIFIED INSTALLER, SPECIFIC TO THE BRAND, TO SEAM THE UNITS IN THE FIELD DURING PRODUCT INSTALLATION.
- STAINLESS STEEL TOPS AND TRAY SLIDES**
- ALL STAINLESS STEEL TOPS AND TRAY SLIDES REQUIRE A CERTIFIED INSTALLER, SPECIFIC TO THE BRAND, TO SEAM THE UNITS IN THE FIELD DURING PRODUCT INSTALLATION.
 - THE MAXIMUM CONTINUOUS STAINLESS STEEL TOP LENGTH IS 14' (12'-0") BEFORE REQUIRING A BOLTED OR WELDED FELD JOINT.
 - ALL BOLTED OR WELDED FELD JOINTS ARE REQUIRED AT ALL INTERIOR TRAY SLIDE CORNERS.
- ALLOWANCE FOR FELD CONDITIONS**
- FACTORY TO ALLOW 1/2" AT ALL WALLS, COLUMNS, AND PASS THROUGH WINDOWS FOR FIT. (SEE WALL TO WALL AND COLUMN EXAMPLES)

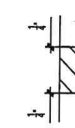

WALL TO WALL EXAMPLE

COLUMN EXAMPLE

ELECTRICAL

- ALL 15 AMP (NEMA # 5-15R) AND 20 AMP (NEMA # 5-20R) RECEPTACLES SHALL BE GFCI (GROUND FAULT CIRCUIT INTERRUPTER) TYPE RECEPTACLES PER DUKE MANUFACTURING STANDARD, UNLESS SPECIFICALLY NOTED OTHERWISE ON THE DRAWING. (SEE SYMBOL LEGEND)

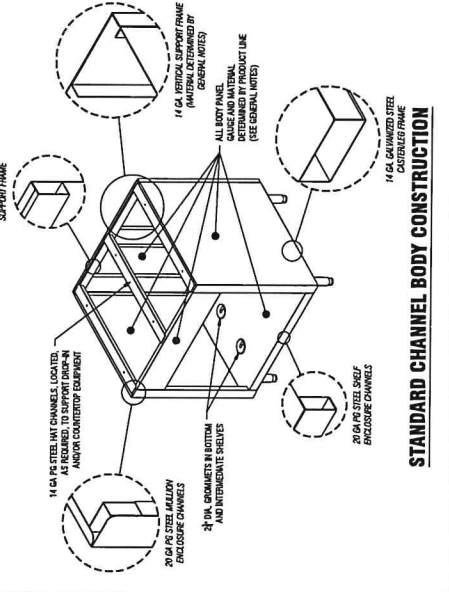

STANDARD CHANNEL BODY CONSTRUCTION

SYMBOL LEGEND

DESCRIPTION	SYMBOL	DESCRIPTION	SYMBOL
SIMPLEX RECEPTACLE	Ⓟ	20 AMP GFCI RECEPTACLE (NEMA 5-15R & 5-20R ONLY)	Ⓟ
RECEPTACLE LOCATION	Ⓧ	LAMINATE LOCATION	Ⓚ
EQUIPMENT TAG	Ⓝ	FELD JOINT LOCATION	Ⓝ
VIEW TAG	④	VIEW NAME	④
VIEW ARROWS	➔	VIEW FACE	➔
		VIEW NUMBER	④
		VIEW PANELS	④

DESCRIPTION	SYMBOL
ELEC. CORD AND PLUS	Ⓢ
DECOR. PANEL LOCATION	Ⓜ
2" CROMMETT LOCATION	Ⓞ
COMPRESSOR WITH REMOVABLE GRILLE	Ⓠ

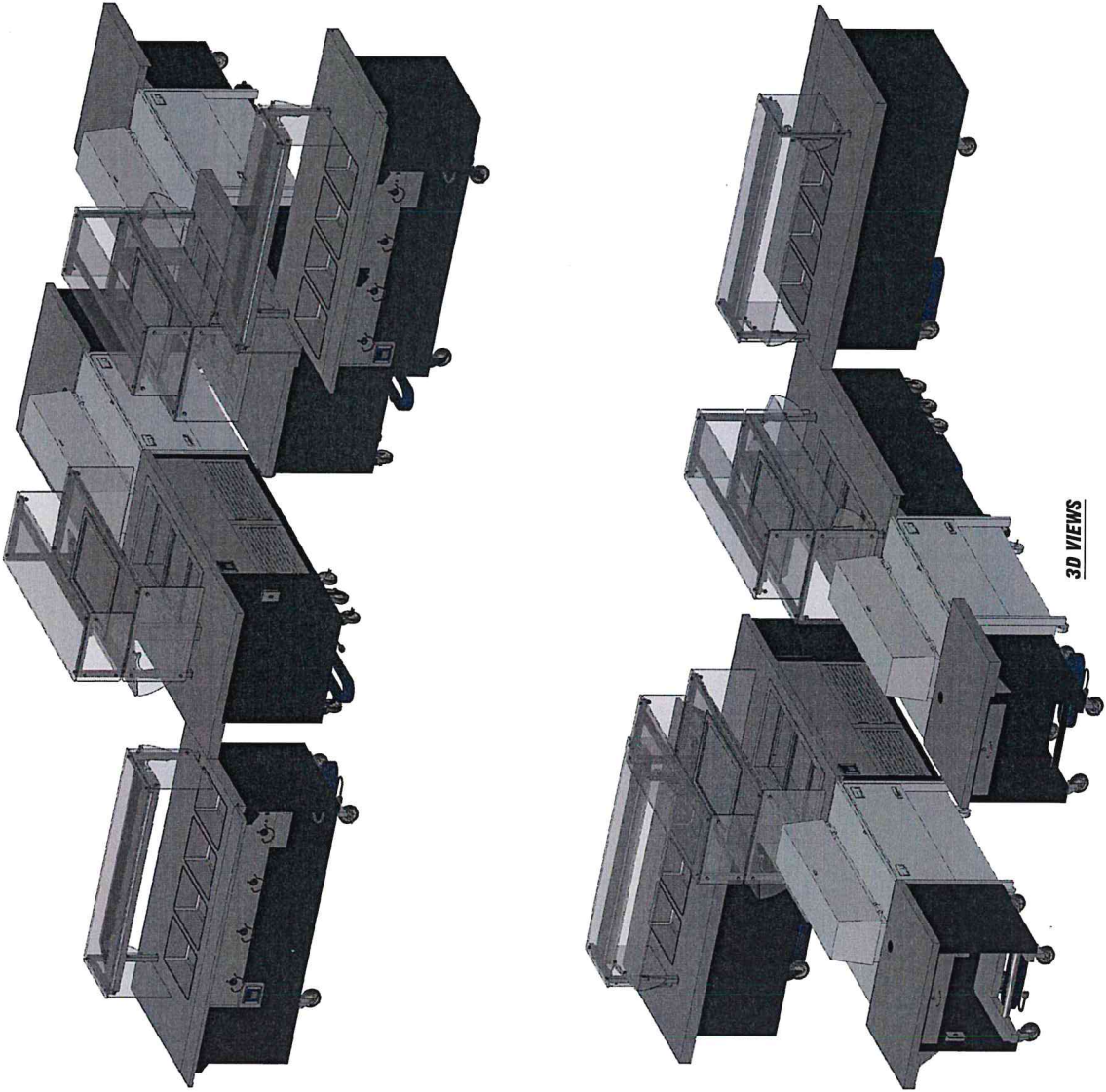

3D VIEWS

GENERAL NOTES

THIS DRAWING AND THE INFORMATION AND DATE CONTAINED HEREIN ARE THE CONFIDENTIAL AND PROPRIETARY PROPERTY OF DUKE MANUFACTURING CO., AND MAY NOT BE REPRODUCED OR DISCLOSED FOR ANY PURPOSE, WITHOUT THE WRITTEN PERMISSION OF DUKE MANUFACTURING CO.

THE FOLLOWING MUST BE VERIFIED PRIOR TO CONSTRUCTION

- ANY DECOR COLOR CHANGES INCLUDING LAMINATE, PAINT COLOR, OR CUSTOM DECOR FEATURES, IF APPLICABLE
- ALL ELECTRICAL VOLTAGE AND PHASE OF DUKE HOT FOOD UNITS AND BUYOUT EQUIPMENT IF APPLICABLE
- ALL CRITICAL FIELD DIMENSIONS IF ANY, AS INDICATED IN PLAN VIEW.

THURMADUKE SERVING SYSTEMS

TOPS
1 1/4" GA. STAINLESS STEEL EXTENDED TOP WITH FROD BRACKET, 3" TOP TURN DOWN ON CUSTOMERS SIDE AND ENDS FOR LED UNDERCOUNTER LIGHTING

BODIES & INTERIORS
1 1/4" GA. FRAMOSPONS W/30% CA. PAINT GIP ENCLOSURE CHANNELS, BODY PANELS AND INTERIOR SHELVES.

*POMER COAT COLOR.....TEXTURED BLACK # 231125

CASTERS
5/8" CASTERS WITH GRAY POLYURETHANE TIRES. ALL SWIVEL WITH BRAKES.

HOT FOOD DRAINS
DRAINS MANUFACTURED W/ COPPER TUBING TO BRASS MASTER VALVE. EXTEND MASTER VALVE FORWARD, TO INCLUDE HOSE BIB CONNECTION & 4" OF 1/2" DIA. HOSE.

BREATHING GUARDS - BGA

1-1/4" SQUARE STAINLESS STEEL, TUBING FASTENERS, MOUNTED THROUGH TOP WITH 3/16" TEMPERED, CLEAR GLASS SHELVES, AND PROTECTORS. WITH GEMAL FINISH WITH HIGHLIGHTED EDGES

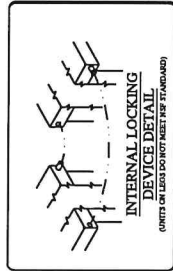

DUKE EQUIPMENT

Item Tag	Quantity	Model Number	Description	Volts	Watts	Area	Count	Depth	Gas Type
1A	1	TCS-38PG	CASHIERS UNIT	120	1800	15	1	15"	5-15P
1B	1	TCS-38PG	CASHIERS UNIT	120	1800	15	1	15"	5-15P
2B	2	TST-18PG	SOLID TOP UNIT	-	-	-	-	-	5-15P
3L	1	TST-40PG	SOLID TOP UNIT	-	-	-	-	-	5-15P
3R	1	TST-40PG	SOLID TOP UNIT	-	-	-	-	-	5-15P
3.1	2	ADJ-3M-HIT	COLD FOOD DRIP-IN UNIT 6" DEEP PAN	120	814	678	1	6"	5-15P
3.2	2	8042-60-SS-GE-L	DUAL TIER, SINGLE SEED BREATHING GUARD TO REDEFINE FRONT OVERSHELF	120	30	25	1	25"	5-15P
3.3	2	FD01-05	RECESSED FRONT TOP DRIP-IN SINK	120	696	5.8	1	5.8"	5-15P
4L	1	TBFH-7HPG	HOT FOOD UNIT SEALED WELLS W/ DRAINS W/ 1/2" IN.	208	3500	17.3	1	17.3"	5-15P
4R	1	TBFH-7HPG	HOT FOOD UNIT SEALED WELLS W/ DRAINS W/ 1/2" IN.	208	3500	17.3	1	17.3"	5-15P
4.1	2	8042-60-SS-GE-L	SINGLE TIER, SINGLE SEED BREATHING GUARD W/ TUBING & LED LIGHTS	120	1000	9	1	9"	5-15P

DUKE EQUIPMENT

Item Tag	Quantity	Model Number	Description	Volts	Watts	Area	Count	Depth	Gas Type
2A	2	RMC3404	MILK COOLER	115	1	264.5	2.3	5-15P	OTHERS

BUY-OUT EQUIPMENT

Item Tag	Quantity	Model Number	Description	Volts	Watts	Area	Count	Depth	Gas Type
2A	2	RMC3404	MILK COOLER	115	1	264.5	2.3	5-15P	OTHERS

STAFF SELF-SERVICE

Item Tag	Quantity	Model Number	Description	Volts	Watts	Area	Count	Depth	Gas Type
6	1	TST-7HPG	SOLID TOP UNIT	-	-	-	-	-	5-15P
7	1	TST-40PG	SOLID TOP UNIT	-	-	-	-	-	5-15P
7.1	1	8042-60-SS-GE-L	DUAL TIER, SINGLE SEED BREATHING GUARD	120	1	34	1	34"	5-15P



DUKE MANUFACTURING COMPANY
3205 Northway Parkway
Carmel, IN 46032
Tel: (317) 221-1130
Fax: (317) 221-2422

SUBMITTAL
DATE: 2/13/2025
BY: ECF
DATE: 2/24/2025
BY: ECF

REV.	DATE	BY
A	2/13/2025	ECF
B	2/24/2025	ECF

TJ ELDER MIDDLE SCHOOL
DRAWN BY: PMR
CHECKED BY: CALM
DATE: 10/25/2024
QUANTITY: SFO-0001273
SHEET: 5 2



Dyer's
Your Satisfaction is Our Only Business

Dyer's
MANUFACTURING
COMPANY

2505 North Broadway
P.O. Box 100
Lansing, MI 48211-1100
Phone (313) 221-1130
Fax (313) 221-5222

NO.	DATE	BY
A	2/13/2025	JECS
B	2/26/2025	JECS

REVISIONS

DATE
BY

PROJECT NO.:
DRAWING NO.:
SHEET: 5 OF 3

DESIGNED FOR:
DESIGNED BY:
CHECKED BY:
DATE: 10/26/2024
DRAWN BY: N/A

TJ ELDER MIDDLE SCHOOL

SFO-0001273

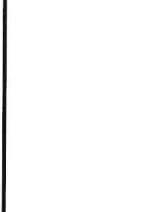
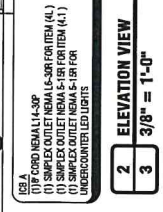
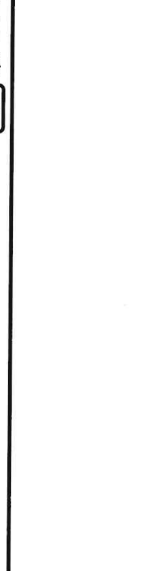
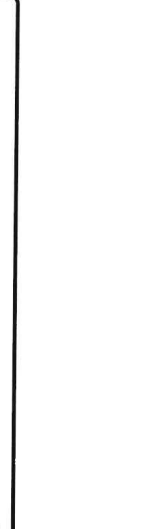
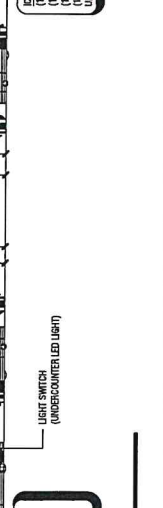
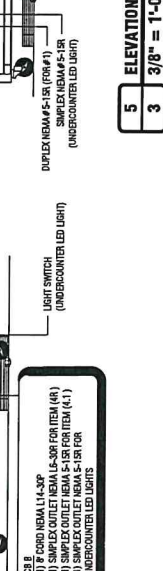
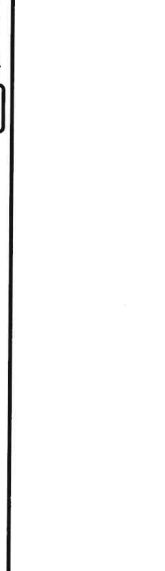
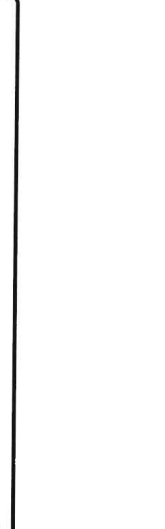
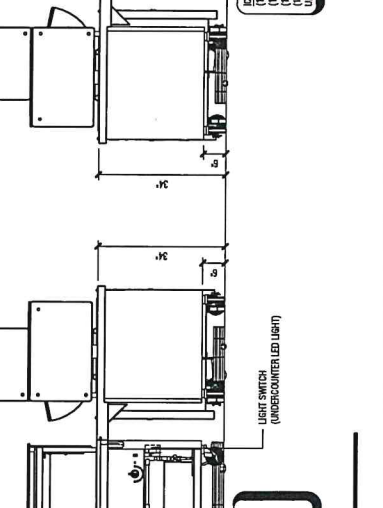
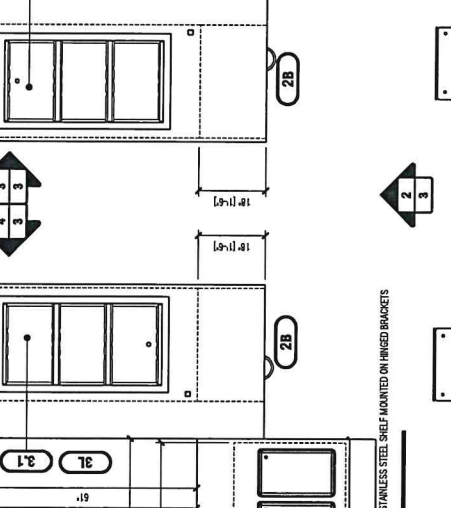
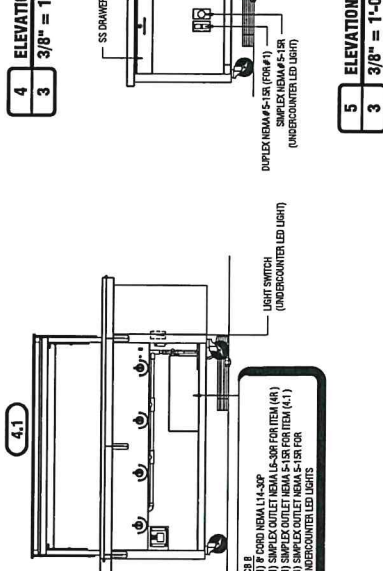
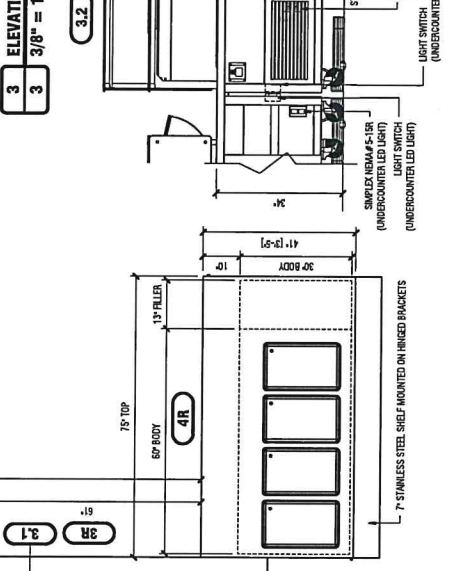
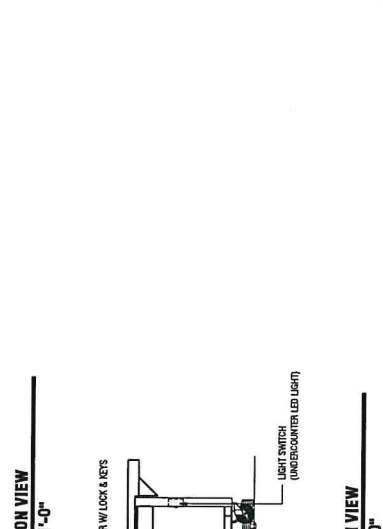
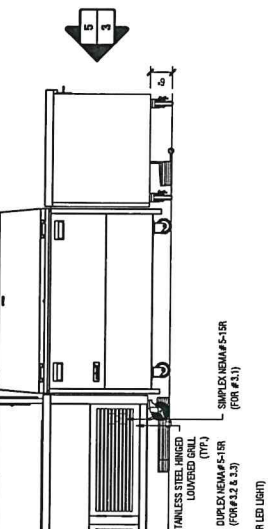
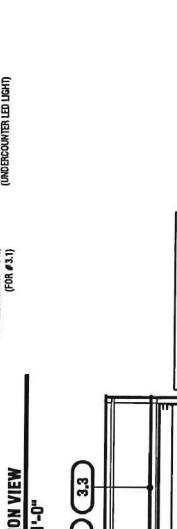
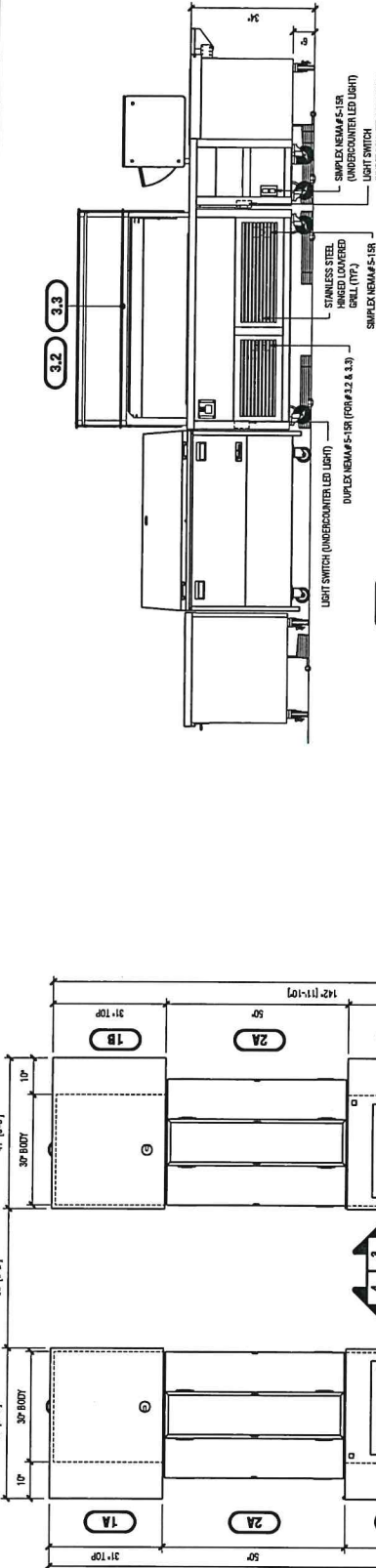



DUKE MANUFACTURING COMPANY
 2305 North Broadway
 P.O. Box 100
 P.O. Box 100
 P.O. Box 100
 P.O. Box 100

REV	DATE	BY	APP
A	2/13/2025	ECS	
B	2/24/2025	ECS	

SUBMITTAL

PROJECT: TJ ELDER MIDDLE SCHOOL
 DRAWN BY: CAM
 CHECKED BY: JSTRITZEL
 DATE: 02/25/2024
 SHEET NO: SFO-001273
 OF: 5

THE DRAWING AND THE INFORMATION AND DATE CONTAINED HEREIN ARE THE CONFIDENTIAL AND PROPRIETARY PROPERTY OF DUKE MANUFACTURING CO., AND MAY NOT BE REPRODUCED OR DISCLOSED FOR ANY PURPOSE, WITHOUT THE WRITTEN PERMISSION OF DUKE MANUFACTURING CO.

STANDARD SERVING SYSTEM PRACTICES

- SOLID SURFACE TOPS AND TRAY SLIDES**
- ALL SOLID SURFACE TOPS AND TRAY SLIDES, WITH FELD SEAMS, WILL SHIP LOOSE, WHEN SPANNING MORE THAN ONE UNIT.
 - SOLID SURFACE TOPS AND TRAY SLIDES SPECIFIC TO SINGLE UNIT WILL SHIP INSTALLED.
 - PRODUCT INSTALLATION, PRODUCT PROTECTION, AND PRODUCT PROTECTION REQUIREMENTS WILL BE THE RESPONSIBILITY OF THE INSTALLER. SPECIFIC TO THE BRAND, TO SEAM THE UNITS IN THE FIELD DURING PRODUCT INSTALLATION.
- STAINLESS STEEL TOPS AND TRAY SLIDES**
- THE MINIMUM LENGTH OF STAINLESS STEEL TOP LENGTH IS 14" (12" + 2"), BEFORE REQUIRING A BOLTED OR WELDED FELD JOINT.
 - THE MAXIMUM LENGTH OF STAINLESS STEEL TOP LENGTH IS 14" (12" + 2"), BEFORE REQUIRING A BOLTED OR WELDED FELD JOINT.
 - BOLTED OR WELDED FELD JOINTS ARE REQUIRED, AT ALL INTERED TRAY SLIDE CORNERS.
- ALLOWANCE FOR FIELD CONDITIONS**
- FACTORY TO ALLOW 1/4" AT ALL WALLS, COLUMNS, AND PASS THROUGH WINDOWS FOR FIT. (SEE WALL TO WALL AND COLUMN EXAMPLES)

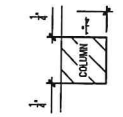

WALL TO WALL EXAMPLE

COLUMN EXAMPLE

ELECTRICAL

- ALL 15 AMP (NEMA #5-15R) AND 20 AMP (NEMA #5-20R) RECEPTACLES SHALL BE GFCI (GROUND FAULT CIRCUIT INTERRUPTER) TYPE RECEPTACLES PER DUKE MANUFACTURING STANDARD, UNLESS SPECIFICALLY NOTED OTHERWISE ON THE DRAWING. (SEE SYMBOL LEGEND)

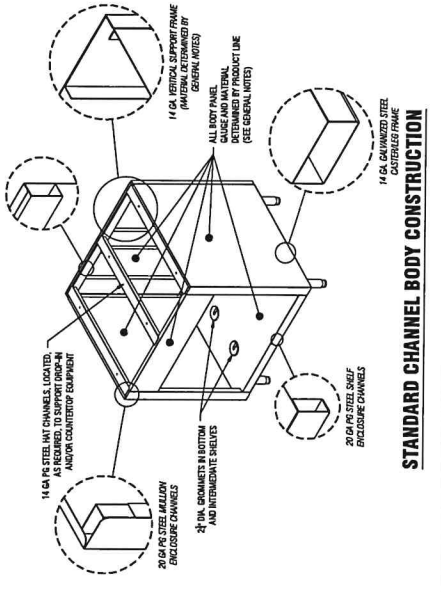

STANDARD CHANNEL BODY CONSTRUCTION

DESCRIPTION	SYMBOL	DESCRIPTION	SYMBOL
SIMPLEX RECEPTACLE	⊞	15 AMP GFCI RECEPTACLE (NEMA #5-15R & #5-20R UNITS)	⊞
RECEPTACLE LOCATION	⊞	RECEPTACLE LOCATION	⊞
EQUIPMENT TAG	#	FIELD JOINT LOCATION	⊞
VIEW TAG	⊞	VIEW NUMBER PER PANEL	⊞
VIEW ARROWS	⊞	VIEW NUMBER PER PANEL	⊞

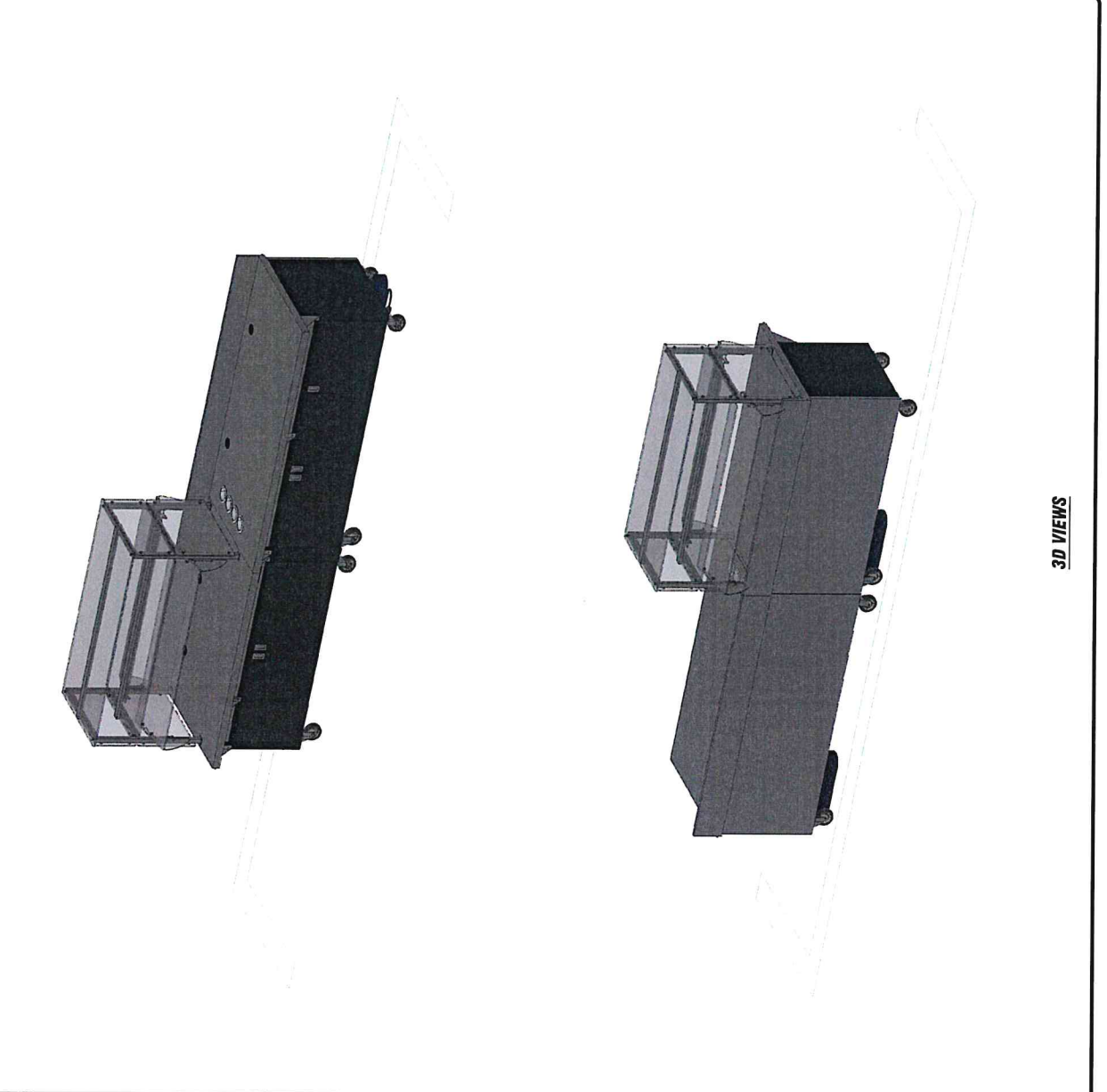

3D VIEWS



DUKE MANUFACTURING COMPANY
 2805 North Broadway
 Ft. Lauderdale, FL 33309
 Tel: (313) 281-1120
 Fax: (313) 281-0874

SUBMITTAL
 THIS DRAWING IS THE PROPERTY OF DUKE MANUFACTURING COMPANY. IT IS TO BE USED ONLY FOR THE PROJECT AND SITE SPECIFICALLY IDENTIFIED HEREON. IT IS NOT TO BE REPRODUCED, COPIED, OR TRANSMITTED IN ANY FORM OR BY ANY MEANS, WITHOUT THE WRITTEN PERMISSION OF DUKE MANUFACTURING COMPANY. THE USER SHALL BE RESPONSIBLE FOR OBTAINING ALL NECESSARY PERMITS AND APPROVALS FROM THE APPROPRIATE AGENCIES. THE USER SHALL BE RESPONSIBLE FOR OBTAINING ALL NECESSARY PERMITS AND APPROVALS FROM THE APPROPRIATE AGENCIES. THE USER SHALL BE RESPONSIBLE FOR OBTAINING ALL NECESSARY PERMITS AND APPROVALS FROM THE APPROPRIATE AGENCIES.

NO.	DATE	BY	DESCRIPTION
1	2/24/2023	ECB	
2			
3			
4			
5			

TJ ELDER MIDDLE SCHOOL
 PROJECT NO. CAM
 ESTIMATOR: JAS TRITZEL
 PROJECT NO. 202302
 SCALE: N/A
 DATE: 06/28/2024
 DRAWING NO.: SFO-0001273
 SHEET: 5

NOTE:
 SNEEZE GUARDS NOT
 SHOWN IN PLAN VIEW

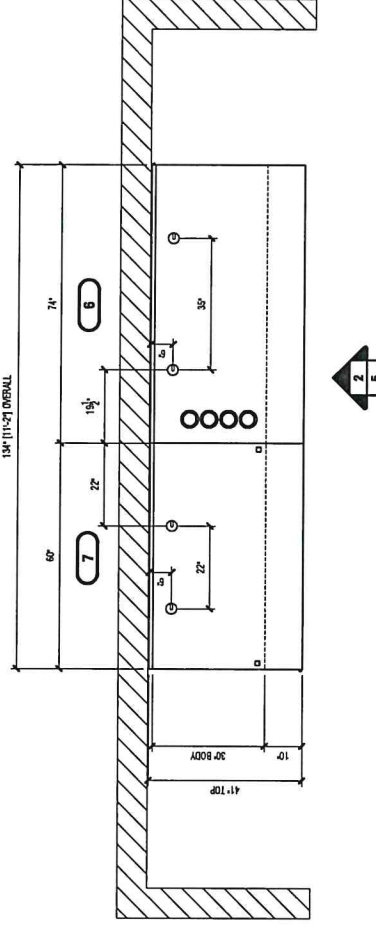

1 PLAN VIEW
 5 3/8" = 1'-0"

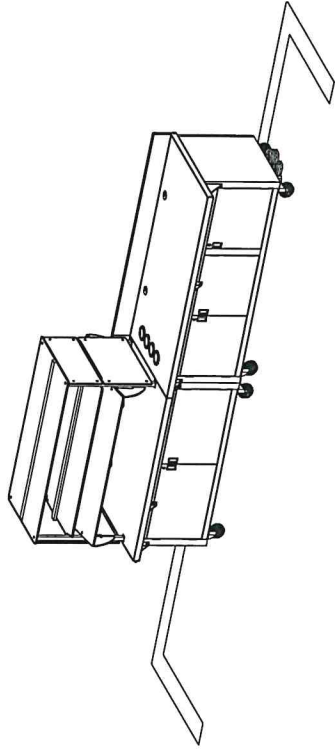

4 ISOMETRIC VIEW
 5 NOT TO SCALE

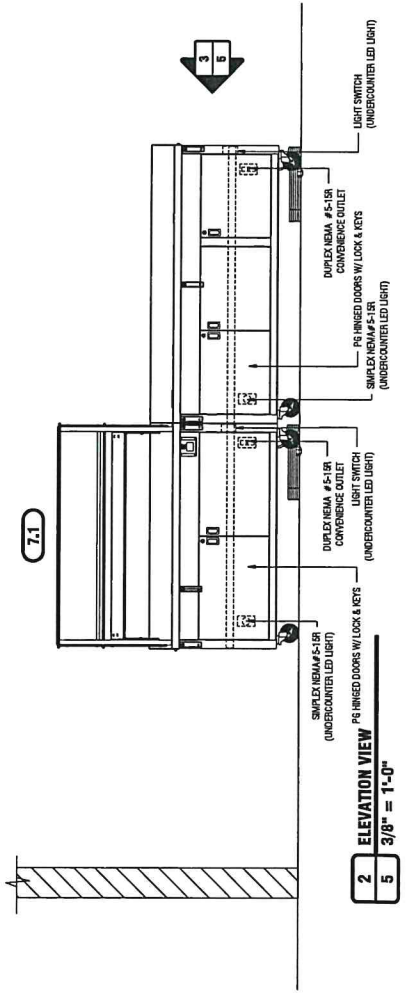

2 ELEVATION VIEW
 5 3/8" = 1'-0"

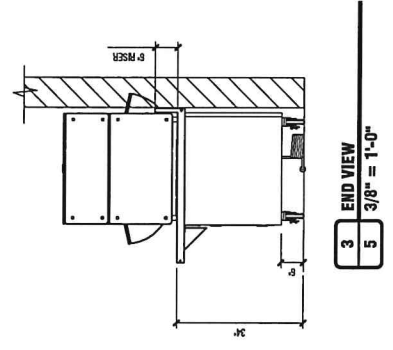

3 END VIEW
 5 3/8" = 1'-0"

Specifications
02/21/2025

Project	From
TJ Elder MS Washington County 902 Linton Road S Sandersville , GA 31082	PMR Lee Richards 1305 Lakes Parkway Suite 106 Lawrenceville, GA 30043 (770)441-3100

NOTE: ITEMS QUOTED ARE POSSIBLY ALTERNATES TO THE SUPPLIED SPECIFICATIONS AND PLAN VIEW DRAWING. ALL PRICING SUBJECT TO CHANGE UPON RECEIPT OF ELEVATION VIEW AND DETAIL VIEW DRAWING. ALL ITEMS ARE QUOTED USING DUKE MANUFACTURING'S STANDARDS OF MATERIALS, DESIGN AND CRAFTSMANSHIP.

ITEM 1A - CASH REGISTER STAND (1 REQ'D)

Duke Manufacturing Model TCS-30PG Dimensions: 36(h) x 30(w) x 32(d)

Thurmaduke™ Cashier Stand, mobile, 30"W, 32"D, 36"H, 16ga stainless top, 20ga paint grip steel body & partial undershelf, stainless steel tube foot rest, 5" dia. gray poly swivel casters & brakes, NSF

- 1 ea Model 217125 Textured Black powder coat paint finish
- 1 ea Model CS-DR-LK Stainless steel drawer, with lock and keys, for cashier stand
- 1 ea Model MOD-14-2 14ga stainless steel top, in lieu of standard
- 1 ea Model MOD-12-32 Extend width of top up to 12", for a 44" or less overall top, with stainless steel fixed brackets
41" Tops
- 1 ea Model ILD Internal Locking Device (on both ends), stainless steel pin & latch line up device under countertop, per unit price (Note: Units required to be portable)
- 1 ea Model CORD 6 ft. cord & plug
- 2 ea Model E-OP2 Electric outlet, mounted in base, with galvanized junction box, duplex or single receptacle & stainless steel cover, wired to existing power source
- 1 ea Model MOD-HT Special Height Body, per unit
- 1 ea Model MOD-HT-34 34" Height Body
- 1 ea Model LED-30 Lights under tray slide 30", trayslide pushed up tight to the top/body with 3" turn down edge.

- 1 ea ON & OFF switch for lights, mounted in base

ITEM 1B - CASH REGISTER STAND (1 REQ'D)

Duke Manufacturing Model TCS-30PG Dimensions: 36(h) x 30(w) x 32(d)

Thurmaduke™ Cashier Stand, mobile, 30"W, 32"D, 36"H, 16ga stainless top, 20ga paint grip steel body & partial undershelf, stainless steel tube foot rest, 5" dia. gray poly swivel casters & brakes, NSF

- 1 ea Model 217125 Textured Black powder coat paint finish
- 1 ea Model CS-DR-LK Stainless steel drawer, with lock and keys, for cashier stand
- 1 ea Model MOD-14-2 14ga stainless steel top, in lieu of standard
- 1 ea Model MOD-12-32 Extend width of top up to 12", for a 44" or less overall top, with stainless steel fixed brackets
41" Tops
- 1 ea Model ILD Internal Locking Device (on both ends), stainless steel pin & latch line up device under countertop, per unit price (Note: Units required to be portable)
- 1 ea Model CORD 6 ft. cord & plug

- 2 ea Model E-OP2 Electric outlet, mounted in base, with galvanized junction box, duplex or single receptacle & stainless steel cover, wired to existing power source
- 1 ea Model MOD-HT Special Height Body, per unit
- 1 ea Model MOD-HT-34 34" Height Body
- 1 ea Model LED-30 Lights under tray slide 30", trayslide pushed up tight to the top/body with 3" turn down edge.

- 1 ea ON & OFF switch for lights, mounted in base

ITEM 2B - SERVING COUNTER, UTILITY (2 REQ'D)

Duke Manufacturing Model TST-18PG Dimensions: 36(h) x 18(w) x 32(d)
 Thurmaduke™ Solid Top Unit, utility counter, 18"W x 32"D x 36"H, 16ga stainless steel top, 20ga paint grip steel body & undershelves, 6"H stainless steel legs with adjustable feet (casters prohibited due to tipping), NSF

- 2 ea Model 217125 Textured Black powder coat paint finish
- 2 ea Model MOD-14-1 14ga stainless steel top, in lieu of standard
 Continuous with item 3
- 2 ea Model MOD-12-18 Extend width of top up to 12", for a 44" or less overall top, with stainless steel fixed brackets
 41" Tops
- 2 ea Model ILD Internal Locking Device (on both ends), stainless steel pin & latch line up device under countertop, per unit price (Note: Units required to be portable)
- 2 ea Model CORD 6 ft. cord & plug
- 2 ea Model E-OP2 Electric outlet, mounted in base, with galvanized junction box, duplex or single receptacle & stainless steel cover, wired to existing power source
- 2 ea Model MOD-HT Special Height Body, per unit
- 2 ea Model MOD-HT-34 34" Height Body
- 2 ea ON & OFF switch for lights, mounted in base
- 2 ea Model LED-18 Lights under tray slide 18", trayslide pushed up tight to the top/body with 3" turn down edge.

ITEM 3L - SERVING COUNTER, UTILITY (1 REQ'D)

Duke Manufacturing Model TST-60PG Dimensions: 36(h) x 60(w) x 32(d)
 Thurmaduke™ Solid Top Unit, mobile utility counter, 60"W x 32"D x 36"H, 16ga stainless steel top, 20ga paint grip steel body & undershelves, 5" dia. gray poly swivel casters & brakes, NSF

- 1 ea Model 217125 Textured Black powder coat paint finish
- 1 ea Model MOD-14-4 14ga stainless steel top, in lieu of standard
- 1 ea Model MOD-12-60 Extend width of top up to 12", for a 44" or less overall top, with stainless steel fixed brackets
 41" Tops
- 1 ea Model ILD Internal Locking Device (on both ends), stainless steel pin & latch line up device under countertop, per unit price (Note: Units required to be portable)
- 1 ea Model CORD-8 8 ft. cord & plug
- 2 ea Model E-OP2 Electric outlet, mounted in base, with galvanized junction box, duplex or single receptacle & stainless steel cover, wired to existing power source
 For item 3.1, 3.3
- 1 ea Model CUT-OP2 Rectangular cutout with raw edge, must be 12" or less, in counter top, body panel or a shelf
 In rail for controls

- 1 ea Model CUT-OP3 Rectangular cutout with reinforced edges, in counter top, body panel or a shelf, counter top max. right to left is 4" less than unit length
In countertop for drop-in 3.1
- 1 ea Model MOD-HT Special Height Body, per unit
- 1 ea Model MOD-HT-34 34" Height Body
- 1 ea Model 329-CM Compressor compartment, partial length, stainless steel louvered grill on the right
- 1 ea Hinged louvered door on operator side - left side
- 1 ea Model LED-60 Lights under tray slide 60", trayslide pushed up tight to the top/body with 3" turn down edge.

- 1 ea ON & OFF switch for lights, mounted in base

ITEM 3R - SERVING COUNTER, UTILITY (1 REQ'D)

Duke Manufacturing Model TST-60PG Dimensions: 36(h) x 60(w) x 32(d)
 Thurmaduke™ Solid Top Unit, mobile utility counter, 60"W x 32"D x 36"H, 16ga stainless steel top, 20ga paint grip steel body & undershelves, 5" dia. gray poly swivel casters & brakes, NSF

- 1 ea Model 217125 Textured Black powder coat paint finish
- 1 ea Model MOD-14-4 14ga stainless steel top, in lieu of standard
- 1 ea Model MOD-12-60 Extend width of top up to 12", for a 44" or less overall top, with stainless steel fixed brackets
41" Tops
- 1 ea Model ILD Internal Locking Device (on both ends), stainless steel pin & latch line up device under countertop, per unit price (Note: Units required to be portable)
- 1 ea Model CORD-8 8 ft. cord & plug
- 2 ea Model E-OP2 Electric outlet, mounted in base, with galvanized junction box, duplex or single receptacle & stainless steel cover, wired to existing power source
For item 3.1, 3.3
- 1 ea Model CUT-OP2 Rectangular cutout with raw edge, must be 12" or less, in counter top, body panel or a shelf
In rail for controls
- 1 ea Model CUT-OP3 Rectangular cutout with reinforced edges, in counter top, body panel or a shelf, counter top max. right to left is 4" less than unit length
In countertop for drop-in 3.1
- 1 ea Model MOD-HT Special Height Body, per unit
- 1 ea Model MOD-HT-34 34" Height Body
- 1 ea Model 329-CM Compressor compartment, partial length, stainless steel louvered grill on the right
- 1 ea Hinged louvered door on operator side - left side
- 1 ea Model LED-60 Lights under tray slide 60", trayslide pushed up tight to the top/body with 3" turn down edge.

- 1 ea ON & OFF switch for lights, mounted in base

ITEM 3.1 - COLD FOOD WELL UNIT, DROP-IN, REFRIGERATED (2 REQ'D)

Duke Manufacturing Model ADI-3M-N7 Dimensions: 24(h) x 46.88(w) x 25.5(d)
 Drop-In Cold Food Pan, refrigerated, 46-7/8"W x 25-1/2"D x 24"H, accommodates (3) 4" deep 12" x 20" pans, 300 series stainless steel top with overhang & locking tabs, 8" deep 300 series stainless steel interior liner, steel exterior housing, remote mounted on/off switch with stainless steel face plate (2-3/16"W x 4-1/8"H cutout required), air-cooled condensing unit, (2) adapter bars included, 1" brass drain & plug, R448a, cULus, UL EPH Classified (45-1/2"W x 23-3/4"D cutout required for unit)

- 2 ea Do not fully enclose compressor area. Two unrestricted openings of no less than (200) square inches required in cabinet for proper cooling.
- 2 ea 120v/60/1-ph, 6.78 amps, 1/2 HP, NEMA 5-15P

ITEM 3.2 - SNEEZE GUARD, STATIONARY (2 REQ'D)

Custom Model BGA2-60

Adjustable single sided, double tier breath guard, stainless steel 1.25 square tube with #8 high polish accents. Posts to extend through the top and secure to base, 3/8" tempered glass front panel and serving shelf. Glass to have high polish profiled edges with rounded corners, adheres to current NSF standards. includes LED lights

ITEM 3.3 - COLD SHELF (2 REQ'D)

Duke Manufacturing Model FT1-OS Dimensions: 2.38(h) x 29(w) x 21(d)

Frost Top overshelve, 29"W x 21"D, fits (1) 18 x 26" pan per shelf, programmable color touch screen control, stainless steel body and shelves, self contained refrigeration, 120v/60/1-ph, 5.8 Amps, NEMA 5-15P (must be installed in a DUKE BG/BGA series food guard)

ITEM 4L - HOT FOOD SERVING COUNTER / TABLE (1 REQ'D)

Duke Manufacturing Model TEHF-60PG Dimensions: 36(h) x 60(w) x 32(d)

Thurmaduke™ Hot Food Unit, mobile, electric, 60"W x 32"D x 36"H, 16ga stainless steel top, (4) stainless steel heat wells, drains, copper manifolds, (1) valve, thermostats, dish shelf, 20ga paint grip steel body & undershelf, 5" swivel casters & brakes, 6 ft cord with plug, cULus, UL EPH Classified (NOTE: Electric values & plug configurations change for 3 phase or when adding electric options - Contact Factory for more info)

- 1 ea Model TEHF60-208-1 208v/60/1-ph, 3600 watts, 17.3 amps
- 1 ea Model 217125 Textured Black powder coat paint finish
- 1 ea Model MOD-14-4 14ga stainless steel top, in lieu of standard: Modify to move hot wells as far to operator side as possible with flat rail
- 1 ea Model MOD-12-60 Extend width of top up to 12", for a 44" or less overall top, with stainless steel fixed brackets
41" Tops
- 1 ea Model ILD Internal Locking Device (on both ends), stainless steel pin & latch line up device under countertop, per unit price (Note: Units required to be portable)
- 1 ea Model 442-4S-HD-OP Cutting Board/Shelf, operator's side, 7"D, 18ga stainless steel shelf, (3) hinged brackets, shelf mounted flush to counter top (specify any special height)
- 1 ea Model CORD-8 8 ft. cord & plug
- 1 ea Model E-OP2 Electric outlet, mounted in base, with galvanized junction box, duplex or single receptacle & stainless steel cover, wired to existing power source
- 1 ea Model MOD-HT Special Height Body, per unit
- 1 ea Model MOD-HT-34 34" Height Body
- 1 ea Model MOD-FLR Filler panel for special length, mounted on end, enclosed both sides & end, includes longer counter top, longer tray slide if needed, no other equipment in filler
- 1 ea Model FLLR13 with 13" body filler panel on operators left
- 1 ea Model ICB CUSTOM Electric inter connect box with outlets breakers and cord, mounted in the base
For item 4, 4.1, undercounter lights
- 1 ea ON & OFF switch for lights, mounted in base
- 1 ea Model LED-60 Lights under tray slide 60", trayslide pushed up tight to the top/body with 3" turn down edge.

ITEM 4R - HOT FOOD SERVING COUNTER / TABLE (1 REQ'D)

Duke Manufacturing Model TEHF-60PG Dimensions: 36(h) x 60(w) x 32(d)

Thurmaduke™ Hot Food Unit, mobile, electric, 60"W x 32"D x 36"H, 16ga stainless steel top, (4) stainless steel heat wells, drains, copper manifolds, (1) valve, thermostats, dish shelf, 20ga paint grip steel body & undershelf, 5" swivel casters & brakes, 6 ft cord with plug, cULus, UL EPH Classified (NOTE: Electric values & plug configurations change for 3 phase or when adding electric options - Contact Factory for more info)

- 1 ea Model TEHF60-208-1 208v/60/1-ph, 3600 watts, 17.3 amps
- 1 ea Model 217125 Textured Black powder coat paint finish
- 1 ea Model MOD-14-4 14ga stainless steel top, in lieu of standard: Modify to move hot wells as far to operator side as possible with flat rail
- 1 ea Model MOD-12-60 Extend width of top up to 12", for a 44" or less overall top, with stainless steel fixed brackets
41" Tops
- 1 ea Model ILD Internal Locking Device (on both ends), stainless steel pin & latch line up device under countertop, per unit price (Note: Units required to be portable)
- 1 ea Model 442-4S-HD-OP Cutting Board/Shelf, operator's side, 7"D, 18ga stainless steel shelf, (3) hinged brackets, shelf mounted flush to counter top (specify any special height)
- 1 ea Model CORD-8 8 ft. cord & plug
- 1 ea Model E-OP2 Electric outlet, mounted in base, with galvanized junction box, duplex or single receptacle & stainless steel cover, wired to existing power source
- 1 ea Model MOD-HT Special Height Body, per unit
- 1 ea Model MOD-HT-34 34" Height Body
- 1 ea Model MOD-FLR Filler panel for special length, mounted on end, enclosed both sides & end, includes longer counter top, longer tray slide if needed, no other equipment in filler
- 1 ea Model FLLR13 with 13" body filler panel on operators right
- 1 ea Model ICB CUSTOM Electric inter connect box with outlets breakers and cord, mounted in the base
For item 4, 4.1, undercounter lights
- 1 ea ON & OFF switch for lights, mounted in base
- 1 ea Model LED-60 Lights under tray slide 60", trayslide pushed up tight to the top/body with 3" turn down edge.

ITEM 4.1 - SNEEZE GUARD, STATIONARY (2 REQ'D)

Custom Model BGA1-60-H

Adjustable single sided, single tier breath guard, stainless steel 1.25 square tube with #8 high polish accents. Posts to extend through the top and secure to base, 3/8" tempered glass front panel and serving shelf. Glass to have high polish profiled edges with rounded corners, adheres to current NSF standards. includes LED lights & heater **FOOD GUARD OVER WELLS ONLY**

ITEM 6 - SERVING COUNTER, UTILITY (1 REQ'D)

Duke Manufacturing Model TST-74PG Dimensions: 36(h) x 74(w) x 32(d)

Thurmaduke™ Solid Top Unit, mobile utility counter, 74"W x 32"D x 36"H, 16ga stainless steel top, 20ga paint grip steel body & undershelves, 5" dia. gray poly swivel casters & brakes, NSF

- 1 ea Model 217125 Textured Black powder coat paint finish
- 1 ea Model MOD-14-5 14ga stainless steel top, in lieu of standard
- 1 ea Model MOD-5R 4" to 6" riser (backsplash) on rear
- 1 ea Model MOD-12-74 Extend width of top up to 12", for a 44" or less overall top, with stainless steel fixed brackets
41" Tops

- 1 ea Model ILD Internal Locking Device (on both ends), stainless steel pin & latch line up device under countertop, per unit price (Note: Units required to be portable)
- 1 ea Model CORD-8 8 ft. cord & plug
- 2 ea Model E-OP2 Electric outlet, mounted in base, with galvanized junction box, duplex or single receptacle & stainless steel cover, wired to existing power source
- 4 ea Model CUT-OP1 Round cutout with raw edge, in counter top, body panel or a shelf
(4x) 4" Round cutouts for silverware dispensers
- 1 ea Model MOD-HT Special Height Body, per unit
- 1 ea Model MOD-HT-34 34" Height Body
- 1 ea Model 329-5PG-LK Hinged doors, with lock and keys, paint grip steel, recessed stainless steel pull
Hinged Doors
- 2 ea Model CUT-OP1-G Round cutout with grommet, in counter top, body panel or a shelf (specify cutout diameter & location)
- 1 ea Model LED-74 Lights under tray slide 74", trayslide pushed up tight to the top/body with 3" turn down edge.

- 1 ea ON & OFF switch for lights, mounted in base

ITEM 7 - SERVING COUNTER, UTILITY (1 REQ'D)

Duke Manufacturing Model TST-60PG Dimensions: 36(h) x 60(w) x 32(d)

Thurmaduke™ Solid Top Unit, mobile utility counter, 60"W x 32"D x 36"H, 16ga stainless steel top, 20ga paint grip steel body & undershelves, 5" dia. gray poly swivel casters & brakes, NSF

- 1 ea Model 217125 Textured Black powder coat paint finish
- 1 ea Model MOD-14-4 14ga stainless steel top, in lieu of standard
- 1 ea Model MOD-4R 4" to 6" riser (backsplash) on rear
- 1 ea Model MOD-12-60 Extend width of top up to 12", for a 44" or less overall top, with stainless steel fixed brackets
41" Tops
- 1 ea Model ILD Internal Locking Device (on both ends), stainless steel pin & latch line up device under countertop, per unit price (Note: Units required to be portable)
- 1 ea Model CORD-8 8 ft. cord & plug
- 2 ea Model E-OP2 Electric outlet, mounted in base, with galvanized junction box, duplex or single receptacle & stainless steel cover, wired to existing power source
- 2 ea Model CUT-OP1-G Round cutout with grommet, in counter top, body panel or a shelf
In countertop for cord pass
- 1 ea Model MOD-HT Special Height Body, per unit
- 1 ea Model MOD-HT-34 34" Height Body
- 1 ea Model 329-4PG-LK Hinged doors, with lock and keys, paint grip steel, recessed stainless steel pull
- 1 ea ON & OFF switch for lights, mounted in base
- 1 ea Model LED-60 Lights under tray slide 60", trayslide pushed up tight to the top/body with 3" turn down edge.

ITEM 7.1 - BREATHGUARD (1 REQ'D)

Duke Manufacturing Model BGA2-60-SS-GF-BL

Adjustable double tier breath guard, stainless steel 1.25 square tube with #8 high polish accents. Posts to extend through the top and secure to base, 3/8" tempered glass front panel and serving shelf. Glass to have high polish profiled edges with rounded corners, adheres to current NSF standards. includes LED lights

Please note that freight is not included in this quotation

* Please note: All truck load (TL) counter equipment will ship skidded, banded and shrink wrapped unless otherwise instructed *

*ITEMS ARE QUOTED AT FACTORY STANDARD DISCOUNT *

DUKE-----50%

NOTE: PLEASE COMPARE THIS QUOTATION TO YOUR REQUIRED EQUIPMENT SPECIFICATIONS.

NOTE: IT IS THE RESPONSIBILITY OF THE DEALER TO VERIFY ALL MEASUREMENTS, DIRECTION OF OPERATION, VOLTAGES AND UTILITY SPECIFICATIONS PRIOR TO ORDERING.

NOTE: EQUIPMENT NOT SHOWN ON THIS QUOTATION WILL NOT BE INCLUDED.

NOTE: PLEASE VERIFY CORRECT QUANTITIES PER SPECS AND DRAWINGS.